

**State of California
AIR RESOURCES BOARD**

**Executive Order VR-402-B
Morrison Bros. Phase I Enhanced Vapor Recovery (EVR) System
for Aboveground Storage Tanks (AST)**

WHEREAS, the California Air Resources Board (ARB) has established, pursuant to California Health and Safety Code sections 39600, 39601 and 41954, certification procedures for systems designed for the control of gasoline vapor emissions during the filling of aboveground gasoline storage tanks, in its **CP-206, Certification Procedure for Vapor Recovery Systems at Gasoline Dispensing Facilities Using Aboveground Storage Tanks** (Certification Procedure) as adopted on May 2, 2008 incorporated by reference in title 17, California Code of Regulations, section 94016;

WHEREAS, ARB has established, pursuant to California Health and Safety Code sections 39600, 39601 and 41954, test procedures for determining the compliance of Phase I vapor recovery systems with emission standards;

WHEREAS, Morrison Bros. requested and was granted certification of the Morrison Bros. Phase I EVR System (Morrison Bros. System) for protected AST pursuant to the Certification Procedure on June 22, 2010 by Executive Order VR-402-A;

WHEREAS, Morrison Bros. requested modification of the Morrison Bros. System to include single-wall ASTs, additional components, and alternate installation configurations for existing AST;

WHEREAS, the Certification Procedure provides that the ARB Executive Officer shall issue an Executive Order if he or she determines that the vapor recovery system conforms to all of the applicable requirements set forth in the Certification Procedure; and

WHEREAS, I, Richard W. Corey, California Air Resources Board Executive Officer, find that the Morrison Bros. System conforms with all the requirements set forth in the Certification Procedure and results in a vapor recovery system which is at least 98.0 percent efficient as tested pursuant to the test procedure **TP-201.1, Volumetric Efficiency for Phase I Systems (October 8, 2003)**;

NOW THEREFORE, IT IS HEREBY ORDERED that the Morrison Bros. System is certified to be at least 98.0 percent efficient when used with Standing Loss Control Vapor Recovery Systems certified by Executive Order VR-301 or Executive Order VR-302, as applicable and installed and maintained as specified herein and in the following exhibits. Exhibit 1 contains a list of the certified components, Exhibit 2 contains the performance standards and specifications, typical installation drawings, and maintenance intervals applicable to the Morrison Bros. System as installed in a gasoline dispensing facility (GDF) with an AST. Exhibit 3 contains the manufacturing

specifications. Exhibit 4 contains a test procedure for determination of static pressure performance of vapor recovery systems at gasoline dispensing facilities with AST. Exhibit 5 contains alternate Phase I EVR installation configurations for existing AST.

IT IS FURTHER ORDERED that compliance with the applicable certification requirements, rules and regulations of the Division of Measurement Standards of the Department of Food and Agriculture, the Office of the State Fire Marshal of the Department of Forestry and Fire Protection, and the Division of Occupational Safety and Health of the Department of Industrial Relations are made conditions of this certification.

IT IS FURTHER ORDERED that Morrison Bros. shall provide a warranty for the vapor recovery system and components to the initial purchaser. The warranty shall be passed on to each subsequent purchaser within the warranty period. The manufacturer of components listed in Exhibit 1 not manufactured by Morrison Bros. shall provide a warranty to each of their components certified herein. The warranty shall include the ongoing compliance with all applicable performance standards and specifications, and shall comply with all warranty requirements in Section 17.5 of the Certification Procedure. Morrison Bros. or other manufacturers may specify that the warranty is contingent upon the use of trained installers.

IT IS FURTHER ORDERED that each certified component manufactured by Morrison Bros. shall be performance tested by the manufacturer as provided in Exhibit 3.

IT IS FURTHER ORDERED that the certified Morrison Bros. System shall be installed, operated and maintained in accordance with the **ARB-Approved Installation, Operation and Maintenance Manual for the Morrison Bros. Phase I Enhanced Vapor Recovery System for Aboveground Storage Tanks**. A copy of this Executive Order and manual shall be maintained at each GDF where a certified Morrison Bros. System is installed.

IT IS FURTHER ORDERED that all equipment listed in Exhibit 1, unless exempted, shall be clearly identified with a permanent identification showing the manufacturer's name and model number.

IT IS FURTHER ORDERED that any alteration in the equipment parts, design, installation or operation of the system provided by the manufacturer's certification application or documents and certified hereby is prohibited and deemed inconsistent with this certification unless the alteration has been submitted in writing and approved in writing by the Executive Officer or Executive Officer's delegate.

IT IS FURTHER ORDERED that the following requirements be made a condition of certification. The owner or operator of the Morrison Bros. system shall conduct, and pass, the following tests no later than 60 days after startup and at least once every three years after startup testing, using the following test procedures: Exhibit 4, **Determination of Static Pressure Performance of Vapor Recovery Systems at Gasoline Dispensing Facilities with Aboveground Storage Tanks**. Shorter time

periods may be specified in accordance with local district requirements. Notification of testing, and submittal of test results, shall be done in accordance with local district requirements and pursuant to the policies established by that district. Alternate test procedures, including most recent versions of test procedures listed above, may be used if determined by the ARB Executive Officer or Executive Officer delegate, in writing, to yield equivalent results.

IT IS FURTHER ORDERED that the Morrison Bros. System shall be compatible with gasoline in common use in California at the time of certification. The Morrison Bros. system is not compatible with gasoline that has methanol content greater than 5 percent, ethanol content greater than 10 percent, or methyl tert butyl ether (MTBE) content greater than 15 percent. Any modifications to comply with future California gasoline requirements shall be approved in writing by the Executive Officer or Executive Officer delegate.

IT IS FURTHER ORDERED that Executive Order VR-402-A issued on June 22, 2010 is hereby superseded by this Executive Order. Morrison Bros. systems certified under Executive Order VR-402-A may remain in use at existing installations. This Executive Order shall apply to new installations or major modification of the Phase I system of an existing gasoline dispensing facility.

IT IS FURTHER ORDERED that the certification of the Morrison Bros. System is valid through July 1, 2015.

Executed at Sacramento, California, this 15th day of April 2013.

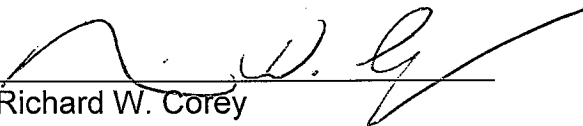
Richard W. Corey
Executive Officer

Attachments:

- Exhibit 1 Equipment List
- Exhibit 2 Installation, Maintenance and Compliance Standards and Specifications
- Exhibit 3 Manufacturing Performance Standards and Specifications
- Exhibit 4 Determination of Static Pressure Performance of Vapor Recovery
Systems at Gasoline Dispensing Facilities with Aboveground Storage
Tanks
- Exhibit 5 Alternative Phase I EVR Installation Configurations for Existing
Aboveground Storage Tanks

**Exhibit 1
Equipment List**

<u>Equipment</u>	<u>Manufacturer/Model Number</u>
Emergency Vent (Figures 1A, 1A-1, and 1A-2)	Morrison 244OxxxxxxAVEVR
Where xxxxxx represented by:	
<u>Model Number</u>	<u>Size</u> <u>Setting</u> <u>Description</u>
244O - - 0170 AVEVR	4" 16oz./sq.in. Emergency Vent - Female Thread
244O - - 0900 AVEVR	5" 16oz./sq.in. Emergency Vent - Female Thread
244O - - 0200 AVEVR	6" 8oz./sq.in. Emergency Vent - Female Thread
244O - - 0400 AVEVR	6" 16oz./sq.in. Emergency Vent - Female Thread
244O - - 0600 AVEVR	8" 8oz./sq.in. Emergency Vent - Female Thread
244O - - 0700 AVEVR	8" 16oz./sq.in. Emergency Vent - Female Thread
244OS - 0170 AVEVR	4" 16oz./sq.in. Emerg. Vent-Female Thd.-w/ Screen
244OS - 0900 AVEVR	5" 16oz./sq.in. Emerg. Vent-Female Thd.-w/ Screen
244OS - 0200 AVEVR	6" 8oz./sq.in. Emerg. Vent-Female Thd.-w/ Screen
244OS - 0400 AVEVR	6" 16oz./sq.in. Emerg. Vent-Female Thd.-w/ Screen
244OS - 0600 AVEVR	8" 8oz./sq.in. Emerg. Vent-Female Thd.-w/ Screen
244OS - 0700 AVEVR	8" 16oz./sq.in. Emerg. Vent-Female Thd.-w/ Screen
244OMA0030 AVEVR	2" 16oz./sq.in. Emergency Vent - Male Thread
244OM - 0060 AVEVR	3" 16oz./sq.in. Emergency Vent - Male Thread
244OM - 0170 AVEVR	4" 16oz./sq.in. Emergency Vent - Male Thread
244OM - 0900 AVEVR	5" 16oz./sq.in. Emergency Vent - Male Thread
244OM - 0200 AVEVR	6" 8oz./sq.in. Emergency Vent - Male Thread
244OM - 0400 AVEVR	6" 16oz./sq.in. Emergency Vent - Male Thread
244OM - 0600 AVEVR	8" 8 oz./sq.in. Emergency Vent - Male Thread
244OM - 0700 AVEVR	8" 16oz./sq.in. Emergency Vent - Male Thread
244OMAS030 AVEVR	2" 16oz./sq.in. Emerg. Vent-Male Thd - w/ Screen
244OMS0060 AVEVR	3" 16oz./sq.in. Emerg. Vent-Male Thd - w/ Screen
244OMS0170 AVEVR	4" 16oz./sq.in. Emerg. Vent-Male Thd - w/ Screen
244OMS0900 AVEVR	5" 16oz./sq.in. Emerg. Vent-Male Thd - w/ Screen
244OMS0200 AVEVR	6" 8oz./sq.in. Emerg. Vent-Male Thd - w/ Screen
244OMS0400 AVEVR	6" 16oz./sq.in. Emerg. Vent-Male Thd - w/ Screen
244OMS0600 AVEVR	8" 8 oz./sq.in. Emerg. Vent-Male Thd - w/ Screen
244OMS0700 AVEVR	8" 16oz./sq.in. Emerg. Vent-Male Thd - w/ Screen

<u>Equipment</u>			<u>Manufacturer/Model Number</u>
<u>Model Number</u>	<u>Size</u>	<u>Setting</u>	<u>Description</u>
244OF - 0170 AVEVR	4"	16oz./sq.in.	Emergency Vent - Flanged
244OF - 0050 AVEVR	6"	8oz./sq.in.	Emergency Vent - Flanged
244OF - 0075 AVEVR	6"	16oz./sq.in.	Emergency Vent - Flanged
244OF - 0100 AVEVR	8"	8oz./sq.in.	Emergency Vent - Flanged
244OF - 0200 AVEVR	8"	16oz./sq.in.	Emergency Vent - Flanged
244OF - 0300 AVEVR	10"	2.5oz./sq.in.	Emergency Vent - Flanged
244OF - 0400 AVEVR	10"	8oz./sq.in.	Emergency Vent - Flanged
244OF - 0500 AVEVR	10"	16oz./sq.in.	Emergency Vent - Flanged
Spill Container (Figure 1B)			Morrison 516xxxxxxxACEVR
Where xxxxxxx represented by:			
<u>Model Number</u>	<u>Size</u>	<u>Description</u>	
516 - - 0400 ACEVR	4" - 5 Gal.	Direct Fill Spill Container – 4" Female Thread	
516O - - 0400 ACEVR	4" - 5 Gal.	Direct Fill Spill Cont. – Offset 4"Female Thrd	
516M - - 0400 ACEVR	4" - 5 Gal.	Direct Fill Spill Container – 4" Male Thread	
516MO - 0400 ACEVR	4" - 5 Gal.	Direct Fill Spill Cont. – Offset 4" Male Thread	
Overfill Prevention Valve & Drop Tube Assembly (Figures 1C, 1C-1, 1C-2, 1C-3, 1C-4, 1C-5, &1D)			Morrison 9095AxxxxxAVEVR (overfill prevention device) Morrison 419xxxxxxx1TEVR (drop tube)
Where xxxxx represented by:			
<u>I.D. Number</u>	<u>Size</u>	<u>Description</u>	
9095A - 9200 AVEVR	2"	OPV Base Model	
9095A - 9300 AVEVR	3"	OPV Base Model	
9095AV9200 AVEVR	2"	OPV Nickel Plated Base Model	
9095AV9300 AVEVR	3"	OPV Nickel Plated Base Model	
9095AA9300 AVEVR	3"	OPV Anodized AL Base Model	
9095A - 5200 AVEVR	2"	Direct Fill OPV with 2" Dry Disconnect x 4" Female Thread Adaptor	
9095AV5200 AVEVR	2"	Direct Fill OPV Nickel Plated with 2" Dry Disc. x 4" Female Thread Adaptor	

<u>Equipment</u>		<u>Manufacturer/Model Number</u>
9095A - 3200 AVEVR	2"	Remote Fill OPV w/2" x 4" Female Thd. Bushing
9095A - 4200 AVEVR	2"	Remote Fill OPV w/3" x 4" Female Thd. Bushing
9095A - 3300 AVEVR	3"	Remote Fill OPV w/3" x 6" Female Thd. Bushing
9095AV3200 AVEVR	2"	Remote Fill OPV Nic. Plat. w/2" x 4" Fem. Bushing
9095AV4200 AVEVR	2"	Remote Fill OPV Nic. Plat. w/3" x 4" Fem. Bushing
9095AV3300 AVEVR	3"	Remote Fill OPV Nic. Plat. w/3" x 6" Fem. Bushing
9095AA3300 AVEVR	3"	Remote Fill OPV Anodize AL w/3" x 6" Fem. Thread Bushing
9095C - 9100 AVEVR	2"	OPV Base Model (For low profile tanks)
9095C - 9200 AVEVR	2"	OPV Base Model
9095CA 9200 AVEVR	2"	OPV Base Model (Fuels w/S.G. less than 0.72)
9095C - 5200 AVEVR	2"	Direct Fill OPV with 2" Dry Disconnect x 4" Female Thread Adaptor
9095CA5200 AVEVR	2"	Direct Fill OPV with 2" Dry Disconnect x 4" Female Thread Adaptor (Fuels w/S.G. less than 0.72)
9095C - 3200 AVEVR	2"	Remote Fill OPV w/2" x 4" Female Thd. Bushing
9095CA3200 AVEVR	2"	Remote Fill OPV w/2" x 4" Female Thd. Bushing (Fuels w/S.G. less than 0.72)
Where xxxxxxxx represented by:		
<u>Model Number</u>	<u>Size</u>	<u>Description</u>
419 - - - YYXX 1TEVR	2" or 3"	Aluminum Drop Tube (Various Lengths)
419A - - YYXX 1TEVR	2" or 3"	Aluminum Drop Tube (Various Lengths Anodized)
	YY = Tube Size	XX = Length In Feet
	02 = 2"	
	03 = 3"	

<u>Equipment</u>		<u>Manufacturer/Model Number</u>	
Non-Rotatable Product Adaptor (Figure 1E)		Morrison 927xxxxxxxAAEVR	
Where xxxxxxx represented by:			
	<u>Model Number</u>	<u>Thread Size</u>	<u>Cam & Groove Size</u> <u>Description</u>
	927 - - - 0200 AAEVR	2"	2.5" Dry Disc. Adaptor (Anodized Al.)
	927 - - - 0300 AAEVR	3"	4" Dry Disc. Adaptor (Anodized Al.)
	927 - - - 0400 AAEVR	4"	4" Dry Disc. Adaptor (Anodized Al.)
Product Adaptor Dust Caps (Figure 1F)		Morrison 735DCxxxxxACEVR	
Where xxxxx represented by:			
	<u>Model Number</u>	<u>Size</u>	<u>Description</u>
	735DC - 2000 ACEVR	2"	Cap -Aluminum
	735DC - 2500 ACEVR	2.5"	Cap -Aluminum
	735DC - 3000 ACEVR	3"	Cap -Aluminum
	735DC - 4000 ACEVR	4"	Cap -Aluminum
	735DCA2000 ACEVR	2"	Cap –Aluminum (Anodized)
	735DCA2500 ACEVR	2.5"	Cap –Aluminum (Anodized)
	735DCA3000 ACEVR	3"	Cap –Aluminum (Anodized)
	735DCA4000 ACEVR	4"	Cap –Aluminum (Anodized)
Examples of Product Adaptors and Dust Cap Combinations:			
<u>Adaptor Size</u>	<u>Model Number</u>	<u>Cap Size</u>	<u>Required Cap Model Number</u>
2"	927 - - - 0200 AAEVR	2.5"	735DC - 2500 ACEVR/735DCA2500 ACEVR
3"	927 - - - 0300 AAEVR	4"	735DC - 4000 ACEVR/735DCA4000 ACEVR
4"	927 - - - 0400 AAEVR	4"	735DC - 4000 ACEVR/735DCA4000 ACEVR
2"x4"	9095A--5201 AAEVR	2.5"	735DC - 2500 ACEVR/735DCA2500 ACEVR

<u>Equipment</u>	<u>Manufacturer/Model Number</u>																
<p>Product Coupler (Figure 1G)</p> <p>Where xxxxxxx represented by:</p> <table border="0"> <thead> <tr> <th><u>Model Number</u></th> <th><u>Thread Size</u></th> <th><u>Cam & Groove Size</u></th> <th><u>Description</u></th> </tr> </thead> <tbody> <tr> <td>928---0150 ACEVR</td> <td>1.5"</td> <td>2"</td> <td>Dry Disconnect Coupler - Aluminum</td> </tr> <tr> <td>928---0200 ACEVR</td> <td>2"</td> <td>2.5"</td> <td>Dry Disconnect Coupler - Aluminum</td> </tr> <tr> <td>928---0300 ACEVR</td> <td>3"</td> <td>4"</td> <td>Dry Disconnect Coupler - Aluminum</td> </tr> </tbody> </table> <p>Note: During fuel deliveries, a MORRISON coupler (928 Series) shall be used with a MORRISON product adaptor (927 Series). The MORRISON 928 Series coupler can be provided by the fuel supplier or provided by the GDF operator. Couplers and adaptors are mated by the cam & groove size. As an example, a 3" Model 928 would mate to a 4" Model 927 because both have a 4" cam & groove size.</p>	<u>Model Number</u>	<u>Thread Size</u>	<u>Cam & Groove Size</u>	<u>Description</u>	928---0150 ACEVR	1.5"	2"	Dry Disconnect Coupler - Aluminum	928---0200 ACEVR	2"	2.5"	Dry Disconnect Coupler - Aluminum	928---0300 ACEVR	3"	4"	Dry Disconnect Coupler - Aluminum	<p>Morrison 928xxxxxxxACEVR</p>
<u>Model Number</u>	<u>Thread Size</u>	<u>Cam & Groove Size</u>	<u>Description</u>														
928---0150 ACEVR	1.5"	2"	Dry Disconnect Coupler - Aluminum														
928---0200 ACEVR	2"	2.5"	Dry Disconnect Coupler - Aluminum														
928---0300 ACEVR	3"	4"	Dry Disconnect Coupler - Aluminum														
<p>Non-Rotatable Vapor Adaptor (Figure 1H)</p> <p>Where xxxxxxx represented by:</p> <table border="0"> <thead> <tr> <th><u>Model Number</u></th> <th><u>Size</u></th> <th><u>Description</u></th> </tr> </thead> <tbody> <tr> <td>323 - - - 0300 AAEVR</td> <td>4" x 3"</td> <td>Vapor Adaptor (Al.) (4" Vapor, 3" Riser Thd.)</td> </tr> <tr> <td>323 - - - 0400 AAEVR</td> <td>4" x 4"</td> <td>Vapor Adaptor (Aluminum)</td> </tr> </tbody> </table>	<u>Model Number</u>	<u>Size</u>	<u>Description</u>	323 - - - 0300 AAEVR	4" x 3"	Vapor Adaptor (Al.) (4" Vapor, 3" Riser Thd.)	323 - - - 0400 AAEVR	4" x 4"	Vapor Adaptor (Aluminum)	<p>Morrison 323xxxxxxxAAEVR</p>							
<u>Model Number</u>	<u>Size</u>	<u>Description</u>															
323 - - - 0300 AAEVR	4" x 3"	Vapor Adaptor (Al.) (4" Vapor, 3" Riser Thd.)															
323 - - - 0400 AAEVR	4" x 4"	Vapor Adaptor (Aluminum)															
<p>Vapor Adaptor Dust Cap (Figure 1I)</p> <p>Where xxxxxxx represented by:</p> <table border="0"> <thead> <tr> <th><u>Model Number</u></th> <th><u>Size</u></th> <th><u>Description</u></th> </tr> </thead> <tbody> <tr> <td>323C - - 0100ACEVR</td> <td>4"</td> <td>Vapor Recovery Cap</td> </tr> </tbody> </table>	<u>Model Number</u>	<u>Size</u>	<u>Description</u>	323C - - 0100ACEVR	4"	Vapor Recovery Cap	<p>Morrison 323CxxxxxxxACEVR</p>										
<u>Model Number</u>	<u>Size</u>	<u>Description</u>															
323C - - 0100ACEVR	4"	Vapor Recovery Cap															

<u>Equipment</u>	<u>Manufacturer/Model Number</u>																											
<p>Dedicated Gauging Port & Drop Tube Assembly (Figures 1J, 1K, and 1D)</p> <p>Where xxxxxxx represented by:</p> <table border="0"> <thead> <tr> <th><u>Model Number</u></th> <th><u>Size</u></th> <th><u>Description</u></th> </tr> </thead> <tbody> <tr> <td>305 - - - 0000 AAEVR</td> <td>2"</td> <td>Adaptor – Brass</td> </tr> <tr> <td>305C - - 2000 ACEVR</td> <td>2"</td> <td>Cap - Aluminum (Anodized)</td> </tr> <tr> <td>305GSP2000 AKEVR</td> <td>2"</td> <td>Cap/Adaptor Kit – Anodized Al. /Brass</td> </tr> </tbody> </table> <p>Where xxxxxxx represented by:</p> <table border="0"> <thead> <tr> <th><u>Model Number</u></th> <th><u>Size</u></th> <th><u>Description</u></th> </tr> </thead> <tbody> <tr> <td>419 - - - YYXX 1TEVR</td> <td>2"</td> <td>Aluminum Drop Tube (Various Lengths)</td> </tr> <tr> <td>419A - - YYXX 1TEVR</td> <td>2"</td> <td>Aluminum Drop Tube (Various Lengths Anodized)</td> </tr> </tbody> </table> <p>YY = Tube Size 02 = 2"</p>	<u>Model Number</u>	<u>Size</u>	<u>Description</u>	305 - - - 0000 AAEVR	2"	Adaptor – Brass	305C - - 2000 ACEVR	2"	Cap - Aluminum (Anodized)	305GSP2000 AKEVR	2"	Cap/Adaptor Kit – Anodized Al. /Brass	<u>Model Number</u>	<u>Size</u>	<u>Description</u>	419 - - - YYXX 1TEVR	2"	Aluminum Drop Tube (Various Lengths)	419A - - YYXX 1TEVR	2"	Aluminum Drop Tube (Various Lengths Anodized)	<p>Morrison 305xxxxxxxAAEVR (Adaptor) Morrison 305CxxxxxxxACEVR (Adaptor Cap) Morrison 419xxxxxxx1TEVR (drop tube)</p>						
<u>Model Number</u>	<u>Size</u>	<u>Description</u>																										
305 - - - 0000 AAEVR	2"	Adaptor – Brass																										
305C - - 2000 ACEVR	2"	Cap - Aluminum (Anodized)																										
305GSP2000 AKEVR	2"	Cap/Adaptor Kit – Anodized Al. /Brass																										
<u>Model Number</u>	<u>Size</u>	<u>Description</u>																										
419 - - - YYXX 1TEVR	2"	Aluminum Drop Tube (Various Lengths)																										
419A - - YYXX 1TEVR	2"	Aluminum Drop Tube (Various Lengths Anodized)																										
<p>Mechanical Tank Gauging (Optional) (Figure 1L and Figure 1M)</p> <p>Where xxxxxxx represented by:</p> <table border="0"> <thead> <tr> <th><u>Model Number</u></th> <th><u>Size</u></th> <th><u>Description</u></th> </tr> </thead> <tbody> <tr> <td>818 - - - 0100 AGEVR</td> <td>2"</td> <td>Clock Gauge</td> </tr> <tr> <td>818 - - - 0400 AGEVR</td> <td>2"</td> <td>Clock Gauge - Drop Tube Float</td> </tr> <tr> <td>818F - - 0100 AGEVR</td> <td>2"</td> <td>Clock Gauge - Female Thread</td> </tr> <tr> <td>818F - - 0400 AGEVR</td> <td>2"</td> <td>Clock Gauge – Fem. Thd. - Drop Tube Float</td> </tr> <tr> <td>818MEF0100 AGEVR</td> <td>2"</td> <td>Clock Gauge-Female Thread -Metric</td> </tr> <tr> <td>818MEF0400 AGEVR</td> <td>2"</td> <td>Clock Gauge-Fem. Thd.-Metric-Drop Tube Float</td> </tr> <tr> <td>818MET0100 AGEVR</td> <td>2"</td> <td>Clock Gauge - Metric</td> </tr> <tr> <td>818MET0400 AGEVR</td> <td>2"</td> <td>Clock Gauge - Metric- Drop Tube Float</td> </tr> </tbody> </table>	<u>Model Number</u>	<u>Size</u>	<u>Description</u>	818 - - - 0100 AGEVR	2"	Clock Gauge	818 - - - 0400 AGEVR	2"	Clock Gauge - Drop Tube Float	818F - - 0100 AGEVR	2"	Clock Gauge - Female Thread	818F - - 0400 AGEVR	2"	Clock Gauge – Fem. Thd. - Drop Tube Float	818MEF0100 AGEVR	2"	Clock Gauge-Female Thread -Metric	818MEF0400 AGEVR	2"	Clock Gauge-Fem. Thd.-Metric-Drop Tube Float	818MET0100 AGEVR	2"	Clock Gauge - Metric	818MET0400 AGEVR	2"	Clock Gauge - Metric- Drop Tube Float	<p>Morrison 818xxxxxxxAGEVR</p>
<u>Model Number</u>	<u>Size</u>	<u>Description</u>																										
818 - - - 0100 AGEVR	2"	Clock Gauge																										
818 - - - 0400 AGEVR	2"	Clock Gauge - Drop Tube Float																										
818F - - 0100 AGEVR	2"	Clock Gauge - Female Thread																										
818F - - 0400 AGEVR	2"	Clock Gauge – Fem. Thd. - Drop Tube Float																										
818MEF0100 AGEVR	2"	Clock Gauge-Female Thread -Metric																										
818MEF0400 AGEVR	2"	Clock Gauge-Fem. Thd.-Metric-Drop Tube Float																										
818MET0100 AGEVR	2"	Clock Gauge - Metric																										
818MET0400 AGEVR	2"	Clock Gauge - Metric- Drop Tube Float																										

<u>Equipment</u>	<u>Manufacturer/Model Number</u>																											
Mechanical Tank Gauging (Optional) (Figure 1L and Figure 1M)	Morrison 918xxxxxxxAGEVR																											
Where xxxxxxxx represented by:																												
<table border="1"> <thead> <tr> <th><u>Model Number</u></th> <th><u>Size</u></th> <th><u>Description</u></th> </tr> </thead> <tbody> <tr> <td>918 - - - 0000 AGEVR</td> <td>2"</td> <td>Clock Gauge w/o Alarm</td> </tr> <tr> <td>918 - - - 2000 AGEVR</td> <td>2"</td> <td>Clock Gauge w/o Alarm-Drop Tube Float</td> </tr> <tr> <td>918F - - 0000 AGEVR</td> <td>2"</td> <td>Clock Gauge w/o Alarm - Female Thread</td> </tr> <tr> <td>918F - - 2000 AGEVR</td> <td>2"</td> <td>Gauge w/o Alarm-Fem. Thd.-Drop Tube Float</td> </tr> <tr> <td>918MEF0000 AGEVR</td> <td>2"</td> <td>Gauge w/o Alarm-Female Thread - Metric</td> </tr> <tr> <td>918MEF2000 AGEVR</td> <td>2"</td> <td>Gauge w/o Alarm-Fem. - Metric -Drop Tube Float</td> </tr> <tr> <td>918MET0000 AGEVR</td> <td>2"</td> <td>Clock Gauge w/o Alarm - Metric</td> </tr> <tr> <td>918MET2000 AGEVR</td> <td>2"</td> <td>Gauge w/o Alarm - Metric -Drop Tube Float</td> </tr> </tbody> </table>	<u>Model Number</u>	<u>Size</u>	<u>Description</u>	918 - - - 0000 AGEVR	2"	Clock Gauge w/o Alarm	918 - - - 2000 AGEVR	2"	Clock Gauge w/o Alarm-Drop Tube Float	918F - - 0000 AGEVR	2"	Clock Gauge w/o Alarm - Female Thread	918F - - 2000 AGEVR	2"	Gauge w/o Alarm-Fem. Thd.-Drop Tube Float	918MEF0000 AGEVR	2"	Gauge w/o Alarm-Female Thread - Metric	918MEF2000 AGEVR	2"	Gauge w/o Alarm-Fem. - Metric -Drop Tube Float	918MET0000 AGEVR	2"	Clock Gauge w/o Alarm - Metric	918MET2000 AGEVR	2"	Gauge w/o Alarm - Metric -Drop Tube Float	
<u>Model Number</u>	<u>Size</u>	<u>Description</u>																										
918 - - - 0000 AGEVR	2"	Clock Gauge w/o Alarm																										
918 - - - 2000 AGEVR	2"	Clock Gauge w/o Alarm-Drop Tube Float																										
918F - - 0000 AGEVR	2"	Clock Gauge w/o Alarm - Female Thread																										
918F - - 2000 AGEVR	2"	Gauge w/o Alarm-Fem. Thd.-Drop Tube Float																										
918MEF0000 AGEVR	2"	Gauge w/o Alarm-Female Thread - Metric																										
918MEF2000 AGEVR	2"	Gauge w/o Alarm-Fem. - Metric -Drop Tube Float																										
918MET0000 AGEVR	2"	Clock Gauge w/o Alarm - Metric																										
918MET2000 AGEVR	2"	Gauge w/o Alarm - Metric -Drop Tube Float																										
Mechanical Tank Gauging (Optional) With Custom Face Label	Morrison 818/918xxxxxxxAGEVR																											
Where xxxxxxxx represented by:																												
<table border="1"> <thead> <tr> <th><u>Model Number</u></th> <th><u>Size</u></th> <th><u>Description</u></th> </tr> </thead> <tbody> <tr> <td>818C - - 0100 AGEVR</td> <td>2"</td> <td>Gauge w/o custom face</td> </tr> <tr> <td>818C - - 0400 AGEVR</td> <td>2"</td> <td>Gauge w/o custom face – Drop Tube Float</td> </tr> <tr> <td>818CF - 0100 AGEVR</td> <td>2"</td> <td>Gauge w/o custom face – Female Thread</td> </tr> <tr> <td>818CF - 0400 AGEVR</td> <td>2"</td> <td>Gauge w/o custom face – Female Thread – Drop Tube Float</td> </tr> <tr> <td>918C - - 2000 AGEVR</td> <td>2"</td> <td>Clock Gauge w/o custom face, w/o Alarm – Drop Tube Float</td> </tr> <tr> <td>918CF - 0000 AGEVR</td> <td>2"</td> <td>Clock Gauge w/o custom face, w/o Alarm – Female Thread</td> </tr> <tr> <td>918CF - 2000 AGEVR</td> <td>2"</td> <td>Clock Gauge w/o custom face, w/o Alarm – Female Thread - Drop Tube Float</td> </tr> </tbody> </table>	<u>Model Number</u>	<u>Size</u>	<u>Description</u>	818C - - 0100 AGEVR	2"	Gauge w/o custom face	818C - - 0400 AGEVR	2"	Gauge w/o custom face – Drop Tube Float	818CF - 0100 AGEVR	2"	Gauge w/o custom face – Female Thread	818CF - 0400 AGEVR	2"	Gauge w/o custom face – Female Thread – Drop Tube Float	918C - - 2000 AGEVR	2"	Clock Gauge w/o custom face, w/o Alarm – Drop Tube Float	918CF - 0000 AGEVR	2"	Clock Gauge w/o custom face, w/o Alarm – Female Thread	918CF - 2000 AGEVR	2"	Clock Gauge w/o custom face, w/o Alarm – Female Thread - Drop Tube Float				
<u>Model Number</u>	<u>Size</u>	<u>Description</u>																										
818C - - 0100 AGEVR	2"	Gauge w/o custom face																										
818C - - 0400 AGEVR	2"	Gauge w/o custom face – Drop Tube Float																										
818CF - 0100 AGEVR	2"	Gauge w/o custom face – Female Thread																										
818CF - 0400 AGEVR	2"	Gauge w/o custom face – Female Thread – Drop Tube Float																										
918C - - 2000 AGEVR	2"	Clock Gauge w/o custom face, w/o Alarm – Drop Tube Float																										
918CF - 0000 AGEVR	2"	Clock Gauge w/o custom face, w/o Alarm – Female Thread																										
918CF - 2000 AGEVR	2"	Clock Gauge w/o custom face, w/o Alarm – Female Thread - Drop Tube Float																										
<table border="1"> <thead> <tr> <th><u>Model Number</u></th> <th><u>Size</u></th> <th><u>Description</u></th> </tr> </thead> <tbody> <tr> <td>AAABCXXXXXY 2L</td> <td>NA</td> <td>Custom Face Label</td> </tr> </tbody> </table>	<u>Model Number</u>	<u>Size</u>	<u>Description</u>	AAABCXXXXXY 2L	NA	Custom Face Label																						
<u>Model Number</u>	<u>Size</u>	<u>Description</u>																										
AAABCXXXXXY 2L	NA	Custom Face Label																										
<p>AAA = Figure No. = 818 or 918 B = Units of Measure G = Gallons L = Liters C = Shape of Tank</p>																												

<u>Equipment</u>	<u>Manufacturer/Model Number</u>																																													
<p>Monitoring Cap and Adaptor (Optional) (Figure 1N)</p> <p>Where xxxxxxx represented by:</p> <table border="1"> <thead> <tr> <th data-bbox="196 520 565 556"><u>Model Number</u></th> <th data-bbox="565 520 662 556"><u>Size</u></th> <th data-bbox="662 520 1421 556"><u>Description</u></th> </tr> </thead> <tbody> <tr> <td>305 - - - 0000 AAEVR</td> <td>2"</td> <td>Monitoring Adaptor - Brass</td> </tr> <tr> <td>305XP - 2200 ACEVR</td> <td>2"</td> <td>Monitoring Cap w/3/8" hole & 3/8" Cable Connector</td> </tr> <tr> <td>305XP - 2400 ACEVR</td> <td>2"</td> <td>Monitoring Cap w/1/2" hole & 1/2" Cable Connector</td> </tr> <tr> <td>305XPA 2200 AKEVR</td> <td>2"</td> <td>Monitoring Cap/Adaptor Kit w/3/8" hole & Cable Con.</td> </tr> <tr> <td>305XPA 2400 AKEVR</td> <td>2"</td> <td>Monitoring Cap/Adaptor Kit w/1/2" hole & Cable Con.</td> </tr> <tr> <td>305 - - - 0200 AAEVR</td> <td>4"</td> <td>Monitoring Adaptor - Brass</td> </tr> <tr> <td>305XP - 0100 ACEVR</td> <td>4"</td> <td>Monitoring Cap w/3/8" hole</td> </tr> <tr> <td>305XP - 1100 ACEVR</td> <td>4"</td> <td>Monitoring Cap w/1/2" hole</td> </tr> <tr> <td>305XP -0200 ACEVR</td> <td>4"</td> <td>Monitoring Cap w/3/8" hole & 3/8" Cable Connector</td> </tr> <tr> <td>305XP -1200 ACEVR</td> <td>4"</td> <td>Monitoring Cap w/1/2" hole & 1/2" Cable Connector</td> </tr> <tr> <td>305XPA0100 AKEVR</td> <td>4"</td> <td>Monitoring Cap/ Adaptor Kit w/3/8" hole</td> </tr> <tr> <td>305XPA1100 AKEVR</td> <td>4"</td> <td>Monitoring Cap/ Adaptor Kit w/1/2" hole</td> </tr> <tr> <td>305XPA0200 AKEVR</td> <td>4"</td> <td>Monitoring Cap/Adaptor Kit w/3/8"hole & Cable Con.</td> </tr> <tr> <td>305XPA1200 AKEVR</td> <td>4"</td> <td>Monitoring Cap/Adaptor Kit w/1/2"hole & Cable Con.</td> </tr> </tbody> </table>	<u>Model Number</u>	<u>Size</u>	<u>Description</u>	305 - - - 0000 AAEVR	2"	Monitoring Adaptor - Brass	305XP - 2200 ACEVR	2"	Monitoring Cap w/3/8" hole & 3/8" Cable Connector	305XP - 2400 ACEVR	2"	Monitoring Cap w/1/2" hole & 1/2" Cable Connector	305XPA 2200 AKEVR	2"	Monitoring Cap/Adaptor Kit w/3/8" hole & Cable Con.	305XPA 2400 AKEVR	2"	Monitoring Cap/Adaptor Kit w/1/2" hole & Cable Con.	305 - - - 0200 AAEVR	4"	Monitoring Adaptor - Brass	305XP - 0100 ACEVR	4"	Monitoring Cap w/3/8" hole	305XP - 1100 ACEVR	4"	Monitoring Cap w/1/2" hole	305XP -0200 ACEVR	4"	Monitoring Cap w/3/8" hole & 3/8" Cable Connector	305XP -1200 ACEVR	4"	Monitoring Cap w/1/2" hole & 1/2" Cable Connector	305XPA0100 AKEVR	4"	Monitoring Cap/ Adaptor Kit w/3/8" hole	305XPA1100 AKEVR	4"	Monitoring Cap/ Adaptor Kit w/1/2" hole	305XPA0200 AKEVR	4"	Monitoring Cap/Adaptor Kit w/3/8"hole & Cable Con.	305XPA1200 AKEVR	4"	Monitoring Cap/Adaptor Kit w/1/2"hole & Cable Con.	<p>Morrison 305xxxxxxxxAAEVR</p>
<u>Model Number</u>	<u>Size</u>	<u>Description</u>																																												
305 - - - 0000 AAEVR	2"	Monitoring Adaptor - Brass																																												
305XP - 2200 ACEVR	2"	Monitoring Cap w/3/8" hole & 3/8" Cable Connector																																												
305XP - 2400 ACEVR	2"	Monitoring Cap w/1/2" hole & 1/2" Cable Connector																																												
305XPA 2200 AKEVR	2"	Monitoring Cap/Adaptor Kit w/3/8" hole & Cable Con.																																												
305XPA 2400 AKEVR	2"	Monitoring Cap/Adaptor Kit w/1/2" hole & Cable Con.																																												
305 - - - 0200 AAEVR	4"	Monitoring Adaptor - Brass																																												
305XP - 0100 ACEVR	4"	Monitoring Cap w/3/8" hole																																												
305XP - 1100 ACEVR	4"	Monitoring Cap w/1/2" hole																																												
305XP -0200 ACEVR	4"	Monitoring Cap w/3/8" hole & 3/8" Cable Connector																																												
305XP -1200 ACEVR	4"	Monitoring Cap w/1/2" hole & 1/2" Cable Connector																																												
305XPA0100 AKEVR	4"	Monitoring Cap/ Adaptor Kit w/3/8" hole																																												
305XPA1100 AKEVR	4"	Monitoring Cap/ Adaptor Kit w/1/2" hole																																												
305XPA0200 AKEVR	4"	Monitoring Cap/Adaptor Kit w/3/8"hole & Cable Con.																																												
305XPA1200 AKEVR	4"	Monitoring Cap/Adaptor Kit w/1/2"hole & Cable Con.																																												
<p>Drop Tube Diffuser (Optional) (Figure 1O)</p> <p>Where xxxxxx represented by:</p> <table border="1"> <thead> <tr> <th data-bbox="196 1360 565 1396"><u>Model Number</u></th> <th data-bbox="565 1360 662 1396"><u>Size</u></th> <th data-bbox="662 1360 1421 1396"><u>Description</u></th> </tr> </thead> <tbody> <tr> <td>539AS - 0200 ADEVR</td> <td>2"</td> <td>AST Diffuser, Slip-on</td> </tr> <tr> <td>539AS - 0300 ADEVR</td> <td>3"</td> <td>AST Diffuser, Slip-on</td> </tr> <tr> <td>539ASA0200 ADEVR</td> <td>2"</td> <td>AST Diffuser, Slip-on (Anodized)</td> </tr> <tr> <td>539ASA0300 ADEVR</td> <td>3"</td> <td>AST Diffuser, Slip-on (Anodized)</td> </tr> <tr> <td>539AT - 0200 ADEVR</td> <td>2"</td> <td>AST Diffuser, Threaded</td> </tr> <tr> <td>539AT - 0300 ADEVR</td> <td>3"</td> <td>AST Diffuser, Threaded</td> </tr> <tr> <td>539ATA0200 ADEVR</td> <td>2"</td> <td>AST Diffuser, Threaded (Anodized)</td> </tr> <tr> <td>539ATA0300 ADEVR</td> <td>3"</td> <td>AST Diffuser, Threaded (Anodized)</td> </tr> </tbody> </table>	<u>Model Number</u>	<u>Size</u>	<u>Description</u>	539AS - 0200 ADEVR	2"	AST Diffuser, Slip-on	539AS - 0300 ADEVR	3"	AST Diffuser, Slip-on	539ASA0200 ADEVR	2"	AST Diffuser, Slip-on (Anodized)	539ASA0300 ADEVR	3"	AST Diffuser, Slip-on (Anodized)	539AT - 0200 ADEVR	2"	AST Diffuser, Threaded	539AT - 0300 ADEVR	3"	AST Diffuser, Threaded	539ATA0200 ADEVR	2"	AST Diffuser, Threaded (Anodized)	539ATA0300 ADEVR	3"	AST Diffuser, Threaded (Anodized)	<p>Morrison 539AxxxxxxADEVR</p>																		
<u>Model Number</u>	<u>Size</u>	<u>Description</u>																																												
539AS - 0200 ADEVR	2"	AST Diffuser, Slip-on																																												
539AS - 0300 ADEVR	3"	AST Diffuser, Slip-on																																												
539ASA0200 ADEVR	2"	AST Diffuser, Slip-on (Anodized)																																												
539ASA0300 ADEVR	3"	AST Diffuser, Slip-on (Anodized)																																												
539AT - 0200 ADEVR	2"	AST Diffuser, Threaded																																												
539AT - 0300 ADEVR	3"	AST Diffuser, Threaded																																												
539ATA0200 ADEVR	2"	AST Diffuser, Threaded (Anodized)																																												
539ATA0300 ADEVR	3"	AST Diffuser, Threaded (Anodized)																																												

<u>Equipment</u>	<u>Manufacturer/Model Number</u>	
Double Tapped Bushing (Optional) (Figure 1P)	Morrison 184xxxxxxx1B or MB	
Where xxxxxxx represented by:		
Double Tapped Bushing (Optional) (Figure 1P)		
<u>Model Number</u>	<u>Size</u>	<u>Description</u>
184 --- 0000 1B	1.5"x.75"x.75"	Double Tapped Bushing
184 --- 0110 1B	1.5"x.5"x.5"	Double Tapped Bushing
184 --- 0120 1B	1.25"x1"x1"	Double Tapped Bushing
184 --- 0130 1B	1.5"x1"x1"	Double Tapped Bushing
184 --- 0100 1B	2"x.38"x38"	Double Tapped Bushing
184 --- 0200 1B	2"x.5"x.5"	Double Tapped Bushing
184 --- 0300 1B	2"x.75"x.75"	Double Tapped Bushing
184 --- 0400 1B	2"x1"x1"	Double Tapped Bushing
184 --- 0500 1B	2"x1.25"x1.25"	Double Tapped Bushing
184 --- 0600 1B	2"x1.5"x1.5"	Double Tapped Bushing
184 --- 0800 1B	2.5"x1.25"x1.25"	Double Tapped Bushing
184 --- 0900 1B	2.5"x1.5"x1.5"	Double Tapped Bushing
184 --- 1000 1B	2.5"x2"x2"	Double Tapped Bushing
184 --- 1100 1B	3"x1"x1"	Double Tapped Bushing
184 --- 1200 1B	3"x1.25"x1.25"	Double Tapped Bushing
184 --- 1300 1B	3"x1.5"x1.5"	Double Tapped Bushing
184 --- 1400 MB	3"x2"x2"	Double Tapped Bushing
184 --- 1500 1B	3"x2.5"x2.5"	Double Tapped Bushing
184 --- 2200 MB	4"x1"x1"	Double Tapped Bushing
184 --- 2300 MB	4"x1.25"x1.25"	Double Tapped Bushing
184 --- 2400 MB	4"x1.5"x1.5"	Double Tapped Bushing
184 --- 2500 MB	4"x2"x2"	Double Tapped Bushing
184 --- 2600 1B	4"x2.5"x2.5"	Double Tapped Bushing
184 --- 2700 MB	4"x3"x3"	Double Tapped Bushing
184S -- 0200 MB	2"x.5"x.5"	Double Tapped Bushing, Stainless Steel
184S -- 0300 MB	2"x.75"x.75"	Double Tapped Bushing, Stainless Steel
184S -- 0400 MB	2"x1"x1"	Double Tapped Bushing, Stainless Steel
184S -- 0500 MB	2"x1.5"x1.5"	Double Tapped Bushing, Stainless Steel
184S -- 2100 MB	4"x.75"x.75"	Double Tapped Bushing, Stainless Steel
184S -- 2200 MB	4"x1"x1"	Double Tapped Bushing, Stainless Steel
184S -- 2400 MB	4"x1.5"x1.5"	Double Tapped Bushing, Stainless Steel
184S -- 2500 MB	4"x2"x2"	Double Tapped Bushing, Stainless Steel
184S -- 2700 MB	4"x3"x3"	Double Tapped Bushing, Stainless Steel

<u>Equipment</u>	<u>Manufacturer/Model Number</u>	
Extractor Fitting (Optional) (Figure 1Q)	Morrison 56XxxxxxxxMBE	
Where Xxxxxxxx represented by:		
Extractor Fitting (Optional) (Figure 1Q)		
<u>Model Number</u>	<u>Size</u>	<u>Description</u>
560 --- 0101 MBE	4" x 4" x 2" x 2"	Extractor Fitting
561 --- 0101 MBE	4" x 4" x 2"	Extractor Fitting
562 --- 0101 MBE	4" x 4" x 3" x 2"	Extractor Fitting
563 --- 0101 MBE	4" X 4" X 3"	Extractor Fitting

Table 1
Components Exempt from Identification Requirements

Component Name	Manufacturer	Model Number
Drop Tube	Morrison	419 - - - YYXX 1TEVR 419A - - YYXX 1TEVR
305 Series Adaptors (dedicated gauging port & monitoring cap and adaptor)	Morrison	305 - - - 0000 AAEVR
Drop Tube Diffuser	Morrison	539A Series
Overfill Prevention Valve	Morrison	9095 Series
Product Coupler	Morrison	928 Series
Double Tapped Bushing	Morrison	184 Series
Extractor	Morrison	56X Series



Figure 1A
Morrison Bros. 244 Series Emergency Vents



Figure 1A-1
Morrison Bros. 244 Series Flanged Emergency Vents

Note: For flange mounted models use gasket material made by Fibreflex. More information is available at <http://www.fibreflex.com>.

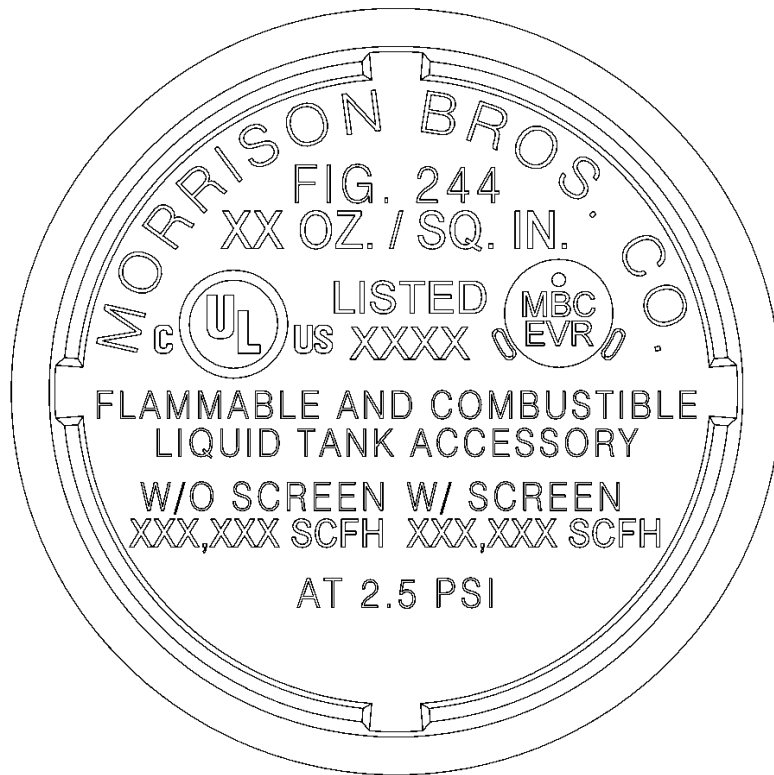

Figure 1A-2
Morrison Bros. 244 Cover Marking Diagram
(The X designation will contain a value which may vary depending upon the size and pressure setting of the vent)

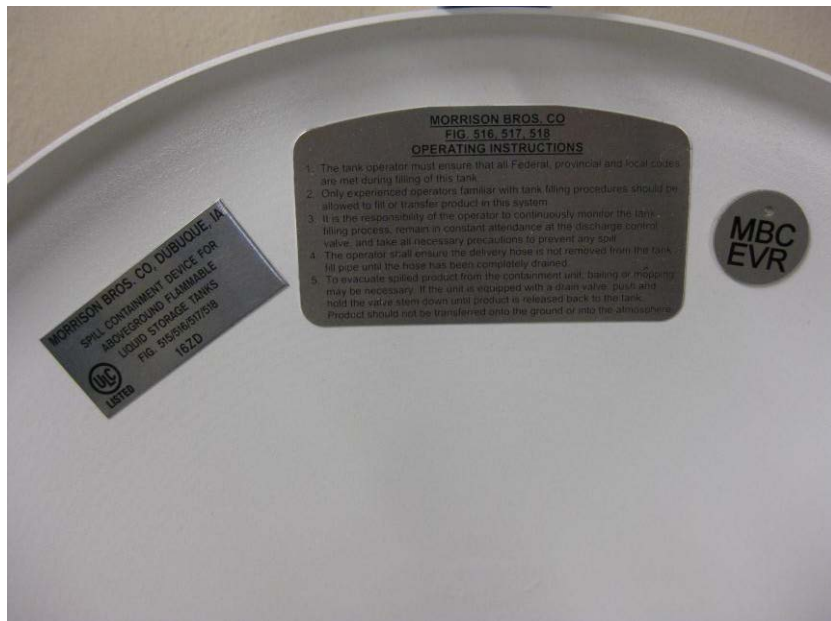

Figure 1B
Morrison Bros. 516 Series Direct Fill Spill Container



Figure 1C
Morrison Bros. 9095A Series Overfill Prevention Valve
Base Model (w/o adaptor or bushing)



Figure 1C-1
Morrison Bros. 9095A Series Overfill Prevention Valve
Direct Fill Model (w/ adaptor)



**Figure 1C-2
Morrison Bros. 9095A Series Overfill Prevention Valve
Remote Fill Model (w/ bushing)**



Figure 1C-3
Morrison Bros. 9095C Series Overfill Prevention Valve
Base Model (w/o adaptor or bushing)



Figure 1C-4
Morrison Bros. 9095C Series Overfill Prevention Valve
Direct Fill Model (w/adaptor)



Figure 1C-5
Morrison Bros. 9095C Series Overfill Prevention Valve
Remote Fill Model (w/ bushing)



Figure 1D
Morrison Bros. 419 Series Drop Tube



Figure 1E
Morrison Bros. 927 Series Non-Rotatable Product Adaptor



Figure 1F
Morrison Bros. 735DC Series Product Dust Cap

Note: The number 713 at the bottom of the cap refers to the aluminum the cap is made of, and not the model number of the cap itself.



Figure 1G
Morrison Bros. 928 Series Product Coupler



Figure 1H
Morrison Bros. 323 Series Non-Rotatable Vapor Adaptor

Morrison Bros. Phase I EVR System For Aboveground Storage Tanks – VR-402-B



Figure 11
Morrison Bros. 323C 0100 ACEVR Vapor Adaptor Dust Cap

Morrison Bros. Phase I EVR System For Aboveground Storage Tanks – VR-402-B



Figure 1J
Morrison Bros. 305 Series Gauge Port Cap



Figure 1K
Morrison Bros. 305 Series Gauge Port Adaptor



Figure 1L
Morrison Bros. 818 Series Mechanical Tank Gauge (optional)



Figure 1M
Morrison Bros. 918 Series Mechanical Tank Gauge With Alarm Output (optional)



Figure 1N
Morrison Bros. 305 Series Monitoring Cap & Adaptor (optional)

Morrison Bros. Phase I EVR System For Aboveground Storage Tanks – VR-402-B



Figure 10
Morrison Bros. 539 Series Drop Tube Diffuser (optional)



Figure 1P
Morrison Bros. 184 Series Double Tapped Bushing (optional)



Figure 1Q
Morrison Bros. Extractor 56X Series (optional)
(Photo is of Fig. 562 4" x 4" x 3" x 2")

Exhibit 2

Installation, Maintenance, and Compliance Standards and Specifications

This exhibit contains the installation, maintenance and compliance standards and specifications applicable to the Morrison Bros. Phase I Enhanced Vapor Recovery (EVR) system (Morrison Bros. System) installed on aboveground storage tanks (AST).

General Specifications

1. Typical installations of the Morrison Bros. System and system components are shown in Figures 2A, 2B, 2C, 2D, 2E, 2F, 2G, 2H, 2I, 2J, 2K, 2L, and 2M.
2. The Morrison Bros. System shall be installed, operated, and maintained in accordance with ***ARB Approved Installation, Operation and Maintenance Manual for the Morrison Bros. Phase I Enhanced Vapor Recovery System for Aboveground Storage Tanks.***
3. Any repair or replacement of system components shall be done in accordance with ***ARB Approved Installation, Operation and Maintenance Manual for the Morrison Bros. Phase I Enhanced Vapor Recovery System for Aboveground Storage Tanks.***
4. Unless otherwise specified in this Executive Order (EO), the Morrison Bros. System shall comply with the applicable performance standards and performance specifications in CP-206.
5. Maintenance and repair of system components, including removal and installation of such components in the course of any required tests, shall be performed by Morrison Certified Technicians.

Non-rotatable Product and Vapor Adaptors

Morrison Bros. non-rotatable vapor adaptors and product adaptors are not specifically certified with an allowable leak rate and shall not leak. Compliance with this requirement shall be verified by the use of commercial liquid leak detection solution or by bagging, when the vapor containment space of AST is subjected to a non-zero pressure. (Note: Leak detection solution will detect leaks only when positive gauge pressure exists).

The bung diameter and associated vapor return piping of AST shall be greater than or equal to the diameter of the Phase I product drop tube. In addition, no liquid condensate traps are allowed within the Phase I vapor return path piping under this configuration.

Product Coupler

Morrison Bros. product couplers shall fit the matching non-rotatable Morrison Bros. product adapters so that spillage of gasoline during fuel deliveries is minimized. During fuel deliveries, a Morrison Bros. coupler (928 Series) shall be used with a Morrison Bros. product adaptor (927 Series). The Morrison Bros. 928 Series coupler can be provided by the fuel supplier or provided by the gasoline dispensing facility (GDF) operator.

Vapor and Product Adaptor Dust Caps

Dust caps with intact gaskets shall be installed on all Phase I product and vapor adaptors.

Emergency Vents

The emergency vents are not specifically certified with an allowable leak rate and shall not leak. Compliance with this requirement shall be verified by the use of commercial liquid leak detection solution or by bagging, when the vapor containment space of AST is subjected to a non-zero pressure. (Note: Leak detection solution will detect leaks only when positive gauge pressure exists).

Direct Fill Spill Container Drain Valve

The Morrison Bros. direct fill spill container does not contain a drain valve and is not specifically certified with an allowable leak rate. Excess liquid is to be evacuated and disposed of according to local and federal regulations.

Dedicated Gauging Port with Drop Tube

A dedicated port for manual tank gauging is used to measure gasoline levels in AST with a gauging stick. The gauging port shall have a drop tube with a Morrison Bros. cap and adapter. The dedicated port and all associated components are not specifically certified with an allowable leak rate and shall not leak. Compliance with this requirement shall be verified by the use of commercial liquid leak detection solution or by bagging, when the vapor containment space of AST is subjected to a non-zero pressure. (Note: Leak detection solution will detect leaks only when positive gauge pressure exists).

Tank Gauge Components (Optional)

The tank gauge components are not specifically certified with an allowable leak rate and shall not leak. Compliance with this requirement shall be verified by the use of commercial liquid leak detection solution or by bagging, when the vapor containment space of an AST is subjected to a non-zero pressure. (Note: Leak detection solution will detect leaks only when positive gauge pressure exists).

Overfill Prevention Valve Assembly & Drop Tube

1. The overfill prevention device (overfill device) is designed to restrict the flow of gasoline delivered to AST when liquid levels exceed a specified capacity.
2. The overfill prevention device is installed below the Morrison Bros. product adaptor (see figure 2A and 2E) which has a built in poppet to prevent vapor leakage and spillage of product after delivery. The overfill prevention device is not specifically certified with an allowable leak rate and the leak rate cannot be determined by testing. Testing to determine the leak rate of the overfill prevention device is not needed since leaks from other components (e.g., product and vapor adaptors, emergency vents, spill container drain valves, dedicated gauging port, tank gauge components, connectors, and fittings) can be determined by procedures specified in this Exhibit.
3. The discharge opening of the drop tube must be entirely submerged when the liquid level is above the bottom of the tank as shown in figures 2A, 2E, 2I, 2J, 2K, 2L, and 2M (see figures for installation details).

Monitoring Cap And Adaptor (Optional)

The monitoring cap and adaptor is not specifically certified with an allowable leak rate and shall not leak. Compliance with this requirement shall be verified by the use of commercial liquid leak detection solution or by bagging, when the vapor containment space of the AST is subjected to a non-zero pressure. (Note: Leak detection solution will detect leaks only when positive gauge pressure exists).

Drop Tube Diffuser (Optional)

The drop tube diffuser is designed to reduce turbulence when filling a tank and minimize vapor generation. The diffuser is not specifically certified with an allowable leak rate and the leak rate cannot be determined by testing. Testing to determine the leak rate of the diffuser is not needed because the device is submerged below the liquid level.

Remote Fill Configuration

Under remote fill configurations (also referred to as side fill), the Phase I vapor recovery piping shall be constructed of galvanized-steel or an equivalent material that has been listed for use with gasoline. If a material other than galvanized steel is used AST operator shall provide a manufacturers' listing demonstrating that the material is compatible for use with gasoline. The diameter and associated vapor return piping of AST shall be greater than or equal to the diameter of the Phase I product drop tube opening. In addition, no liquid condensate traps are allowed within the Phase I vapor return path piping under this configuration. The fill pipe may have to be removed upon District request to verify that the bottom of the fill pipe is no greater than 6 inches from the bottom of the tank.

Connections and Fittings

All connections and fittings not specifically certified with an allowable leak rate shall not leak. Compliance with this requirement shall be verified by the use of commercial liquid leak detection solution or by bagging, when the vapor containment space of the AST is subjected to a non-zero pressure. (Note: Leak detection solution will detect leaks only when positive gauge pressure exists).

Maintenance Records

Each GDF operator/owner shall keep records of maintenance performed at the facility. Such record shall be maintained on site or in accordance with district requirements or policies. The records shall include at a minimum the maintenance or test date, repair date to correct test failure, maintenance or test performed, affiliation, telephone number, name and Certified Technician Identification Number of individual conducting maintenance or test. Additional information may be required in accordance with district requirements. An example of a Phase I Maintenance Record is shown in Figure 2N.

**Table 2-1
AST Compliance Standards and Specifications**

Component / System	Test Method	Standard or Specification
Phase I Adaptors	Leak Detection Solution or Bagging	No Leaks
Emergency Vents	Leak Detection Solution or Bagging	No Leaks
Dedicated gauging port with drop tube and tank gauge components	Leak Detection Solution or Bagging	No Leaks
Vapor Recovery System	Exhibit 4	Exhibit 4 of this Executive Order
All connections and fittings certified without an allowable leak rate	Leak Detection Solution or Bagging	No Leaks

**Table 2-2
Maintenance Intervals for Morrison Bros. Phase I EVR AST System
Components**

Manufacturer	Component	Maintenance Interval
Morrison Bros.	Tank Gauge Components	Annual
Morrison Bros.	Dust Caps	Annual
Morrison Bros.	Emergency Vents	Annual
Morrison Bros.	Phase I Product and Vapor Adaptors	Annual
Morrison Bros.	Spill Container	Annual
Morrison Bros.	Drop Tube Overfill Prevention Device	None
Morrison Bros.	Drop Tube	None
Morrison Bros.	Product Coupler	Annual
Morrison Bros.	Monitoring Caps	Annual
Morrison Bros.	Drop Tube Diffuser	None
Husky Corp.	Pressure/Vacuum Vent Valve 5885	Annual

Figure 2A
Typical Direct Fill (Product Side) Installation of Morrison Bros. Phase I EVR System for AST

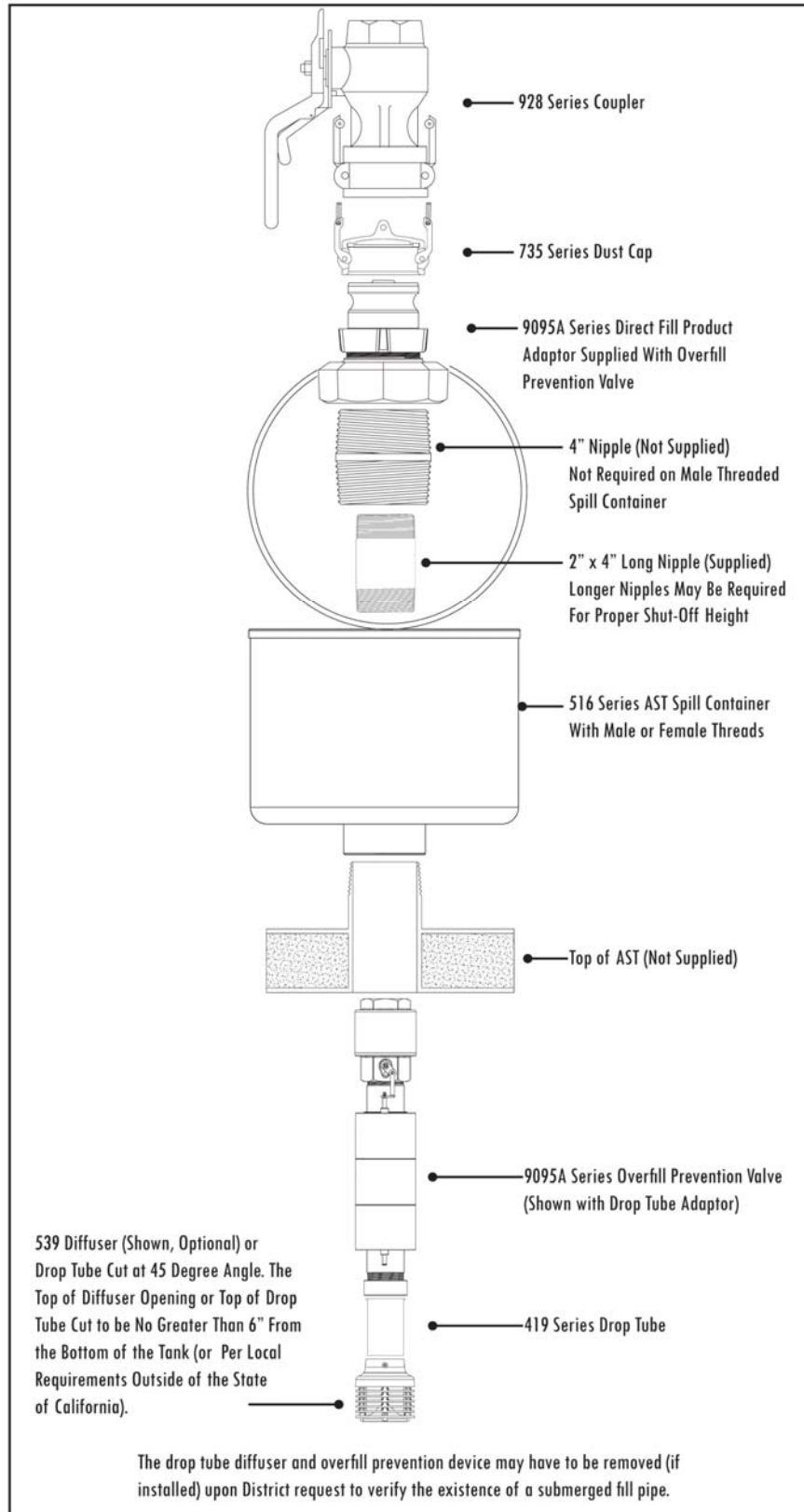

Figure 2B
Typical Vapor Recovery Adaptor Configuration of Morrison Bros. Phase I EVR
System for AST

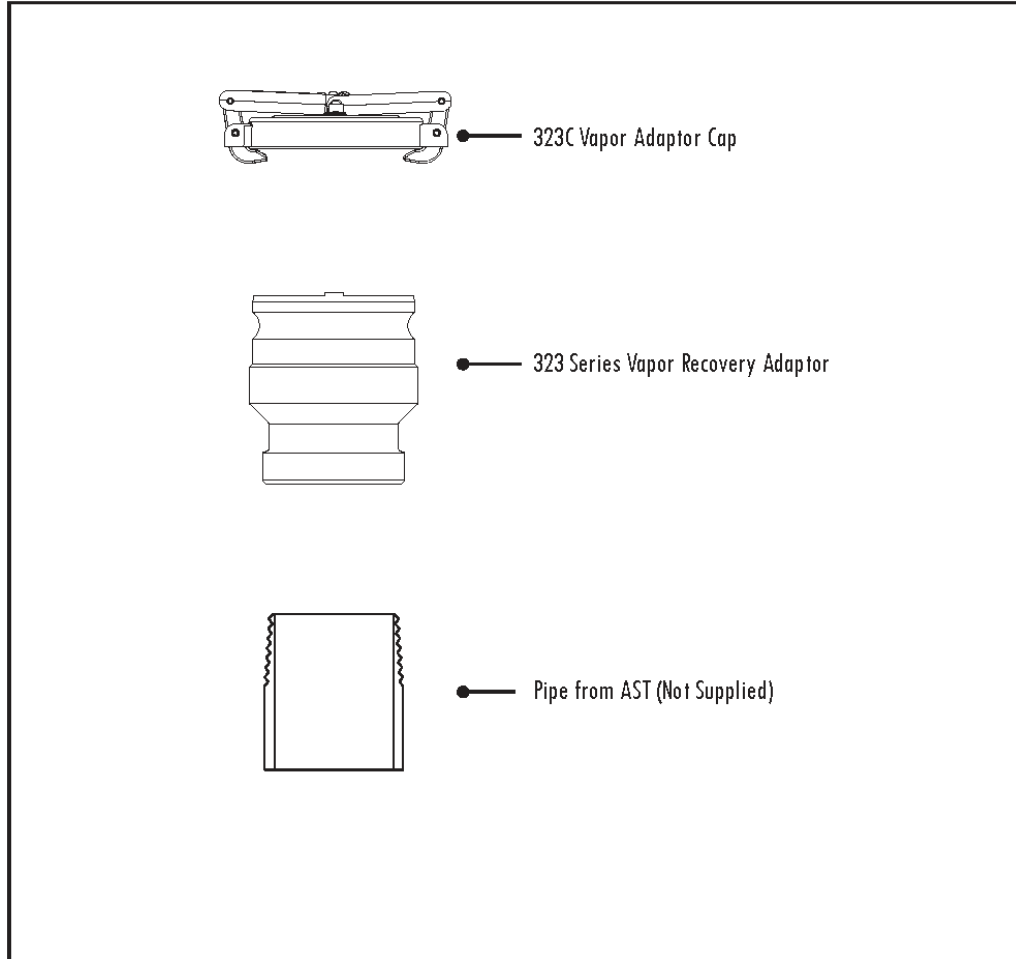
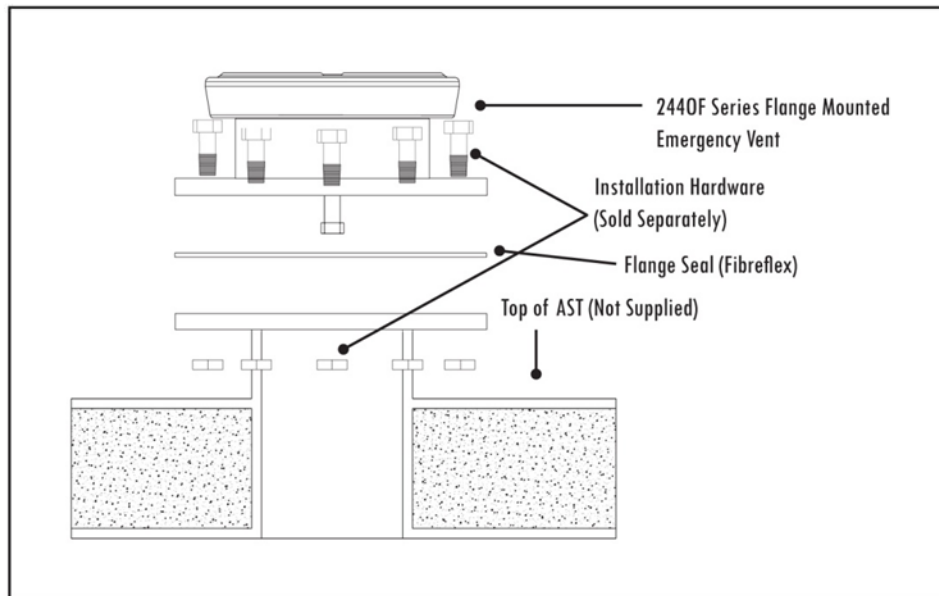
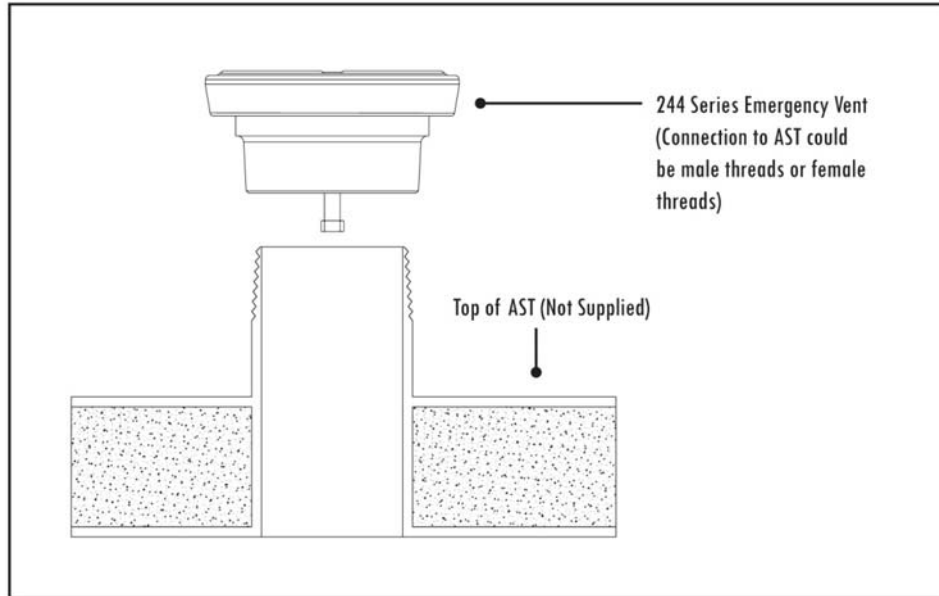

Figure 2C
Typical Emergency Vent Valve Installation of Morrison Bros. Phase I EVR
System – Threaded and Flanged



Note: For flange models, use gasket material made by Fibreflex. More information is available at <http://www.fibreflex.com>.

Figure 2D
Typical Remote Fill Configuration of Morrison Bros. Phase I EVR System for
AST

(Note: The remote spill container is not a vapor recovery component.)

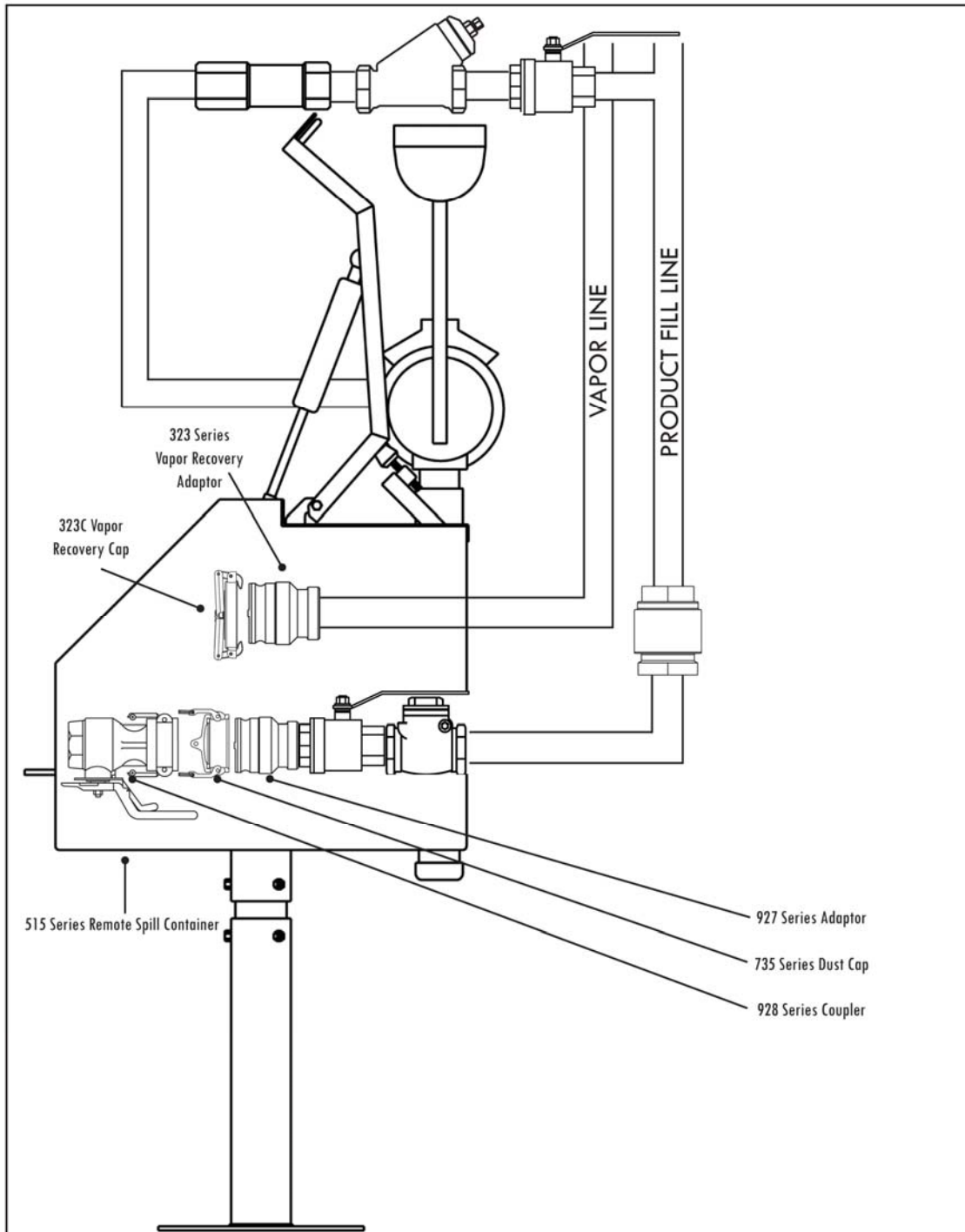

Figure 2E
Typical Remote Product Pathway Configuration for AST – Tank Side

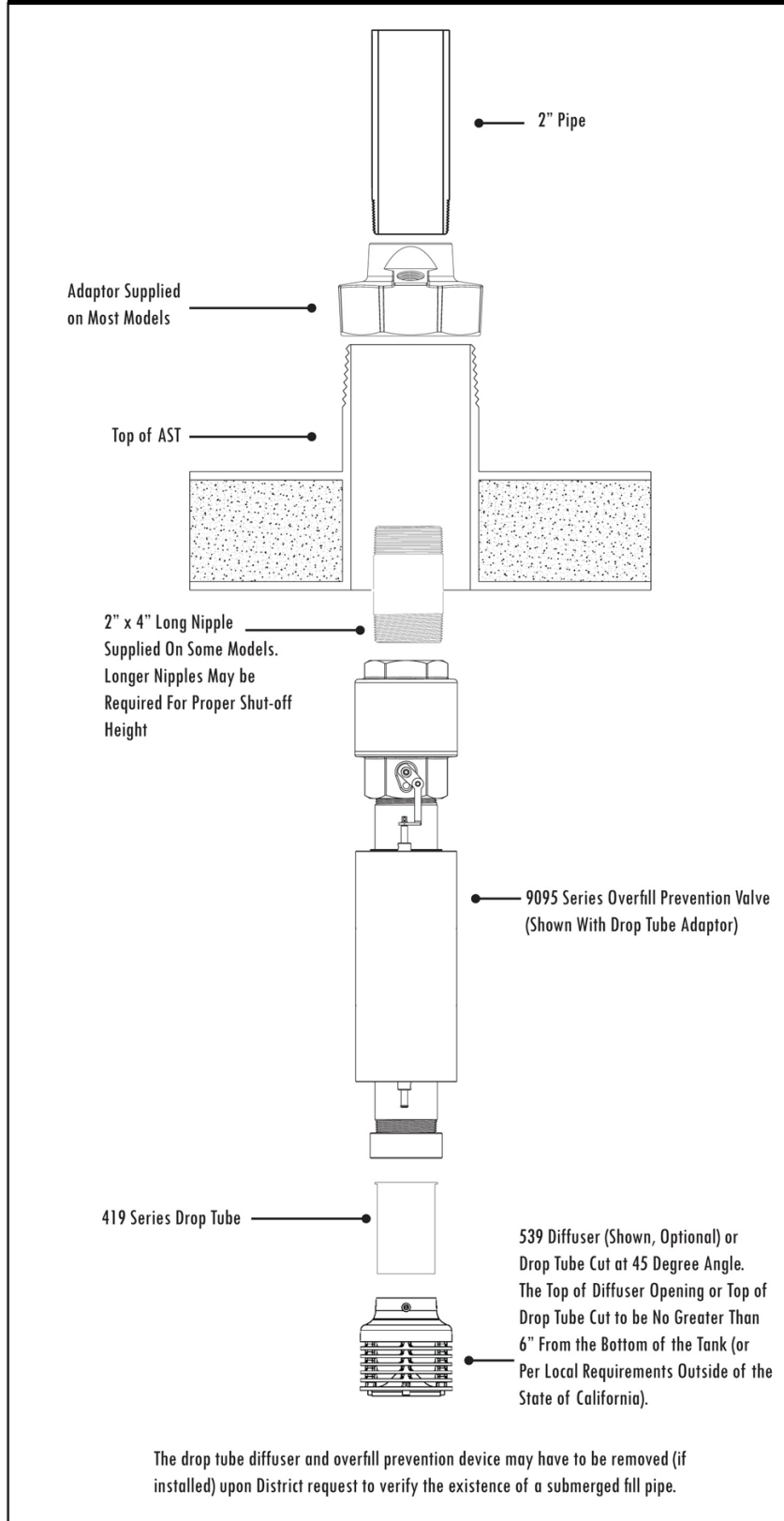

Figure 2F
Typical Morrison Bros. Coupler and adaptor

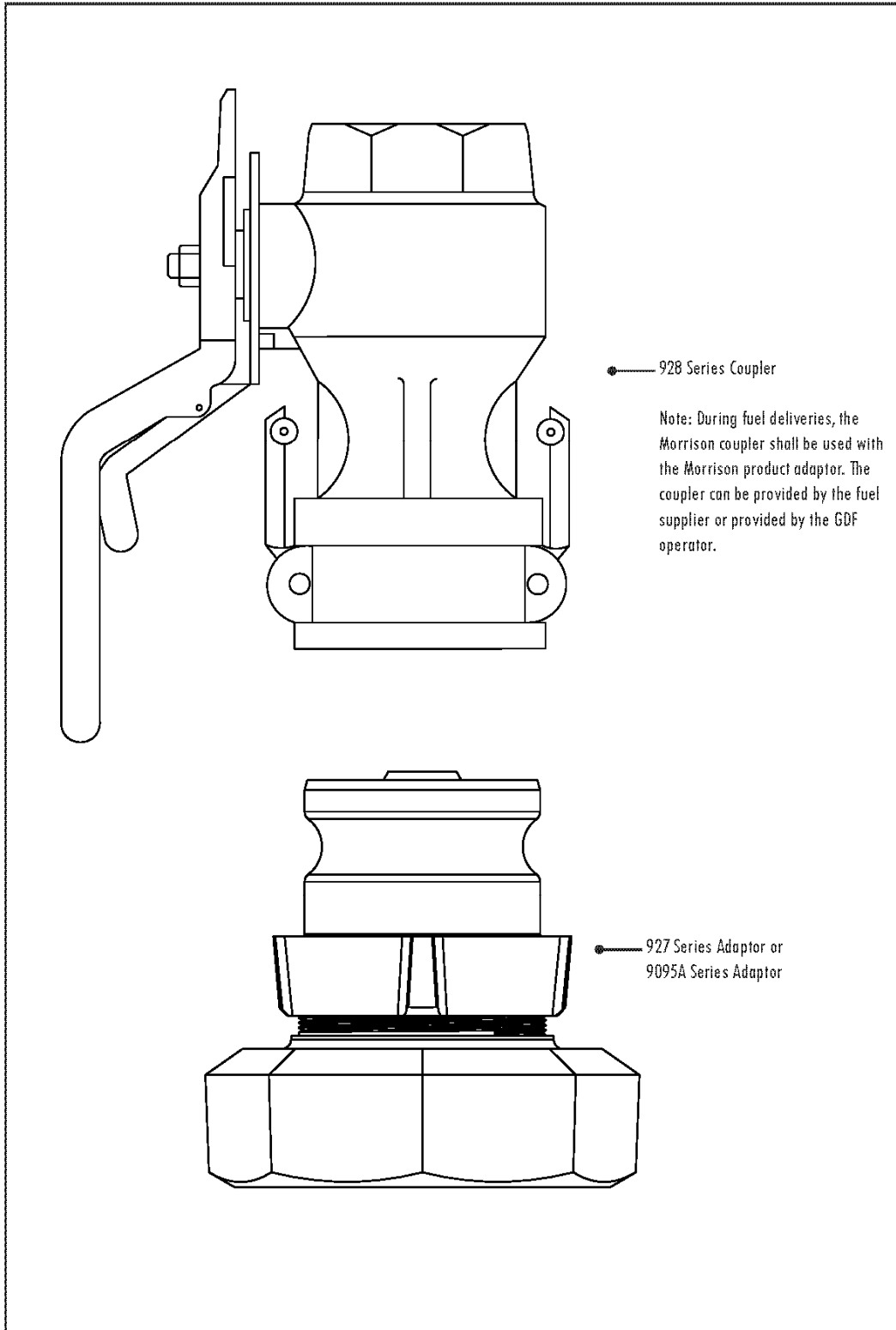

Figure 2G
Typical Mechanical Tank Gauge Configuration of Morrison Bros. Phase I EVR
System for AST (Optional)

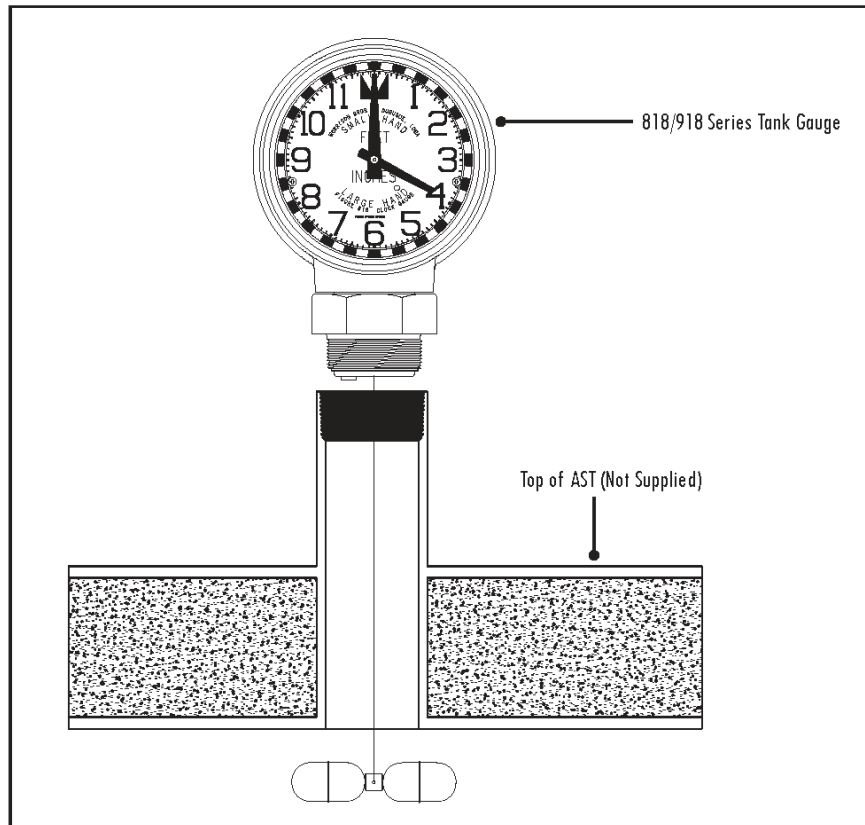

Figure 2H
Typical Dedicated Gauging Port with Drop Tube of Morrison Bros. Phase I EVR
System for AST

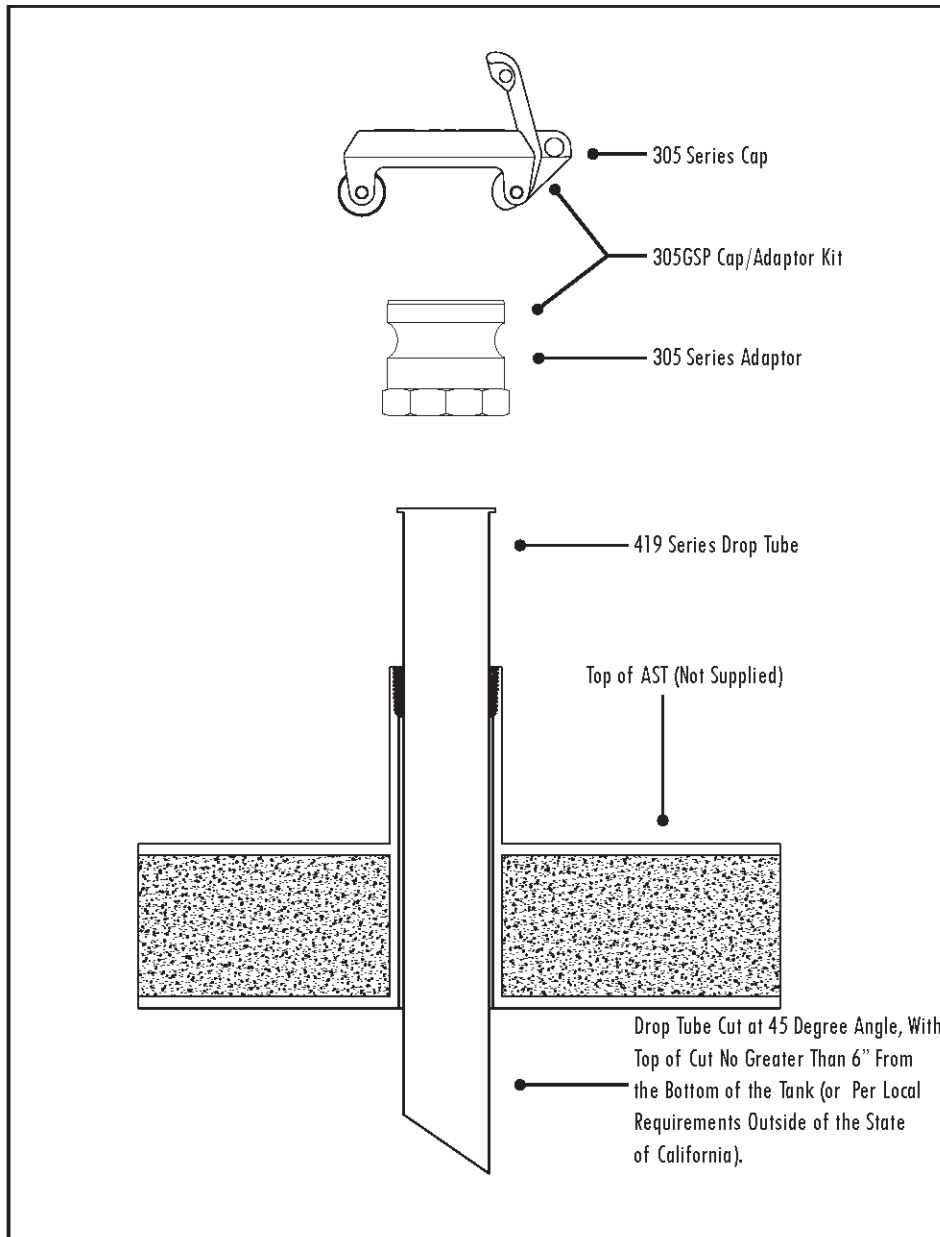

Figure 2I

**Typical Monitoring Cap and Adaptor Configuration for Morrison Bros. Phase I
EVR System for AST**

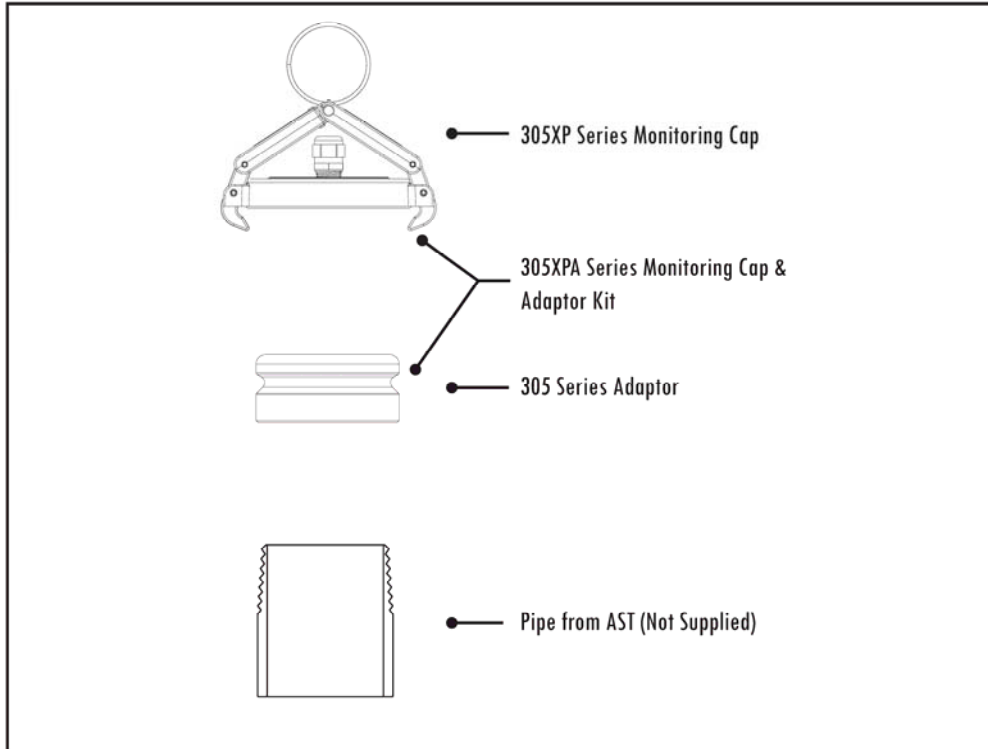
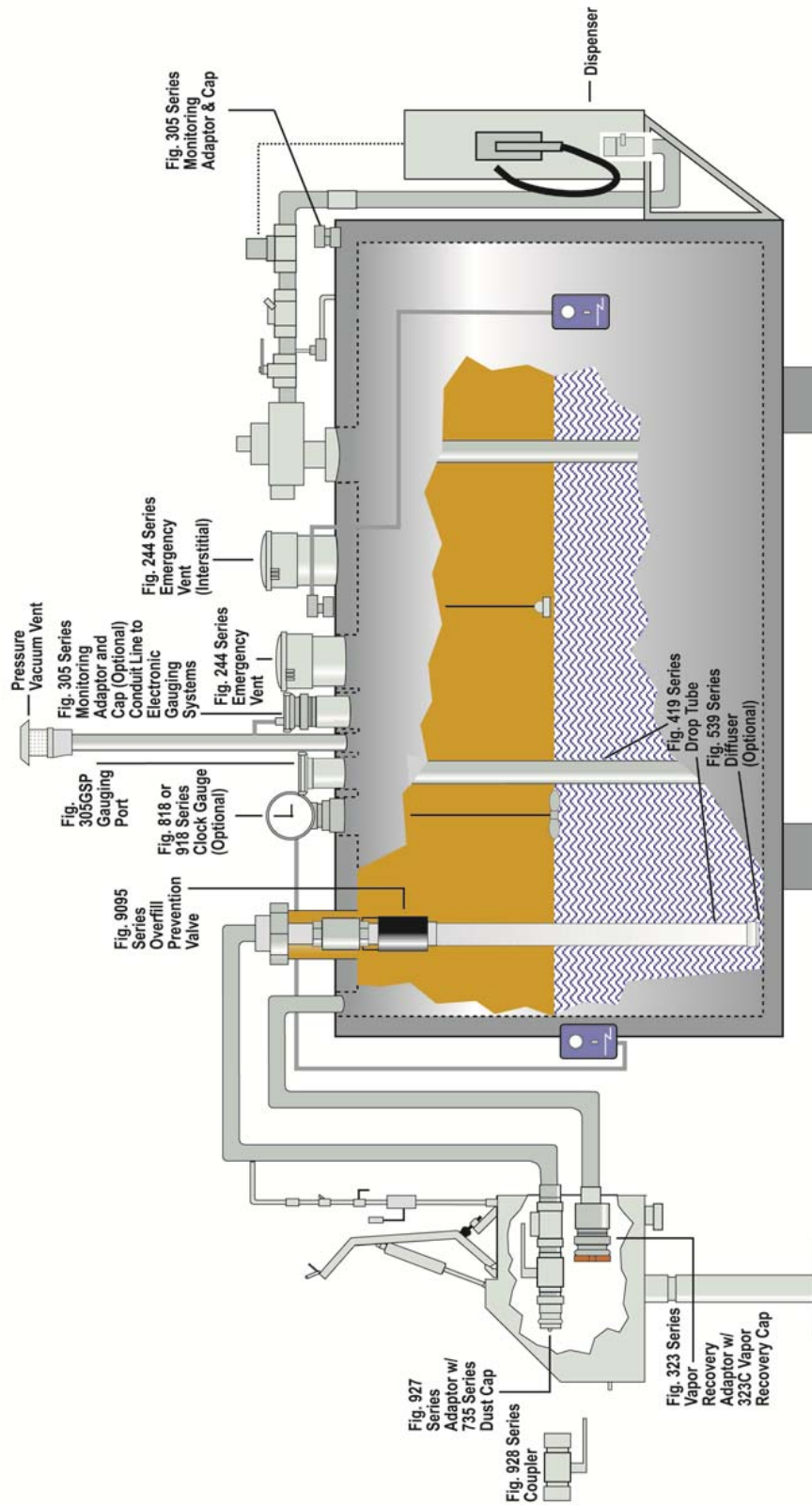

Figure 2J
Aboveground Fuel Storage System With Vapor Recovery Components
 Protected Double-Wall Tank With Remote Fill



Remote Fill systems: 539 diffuser (shown, optional) or drop tube cut at 45 degree angle. The top of diffuser opening or top of drop tube cut to be no greater than 6" from the bottom of the tank (or per local requirements outside of the State of California).

The fill pipe may have to be removed upon District request to verify that the bottom of the fill pipe is no greater than 6" from the bottom of the tank.

Figure 2K
Aboveground Fuel Storage System With Vapor Recovery Components
 Protected Double-Wall Tank With Direct Fill

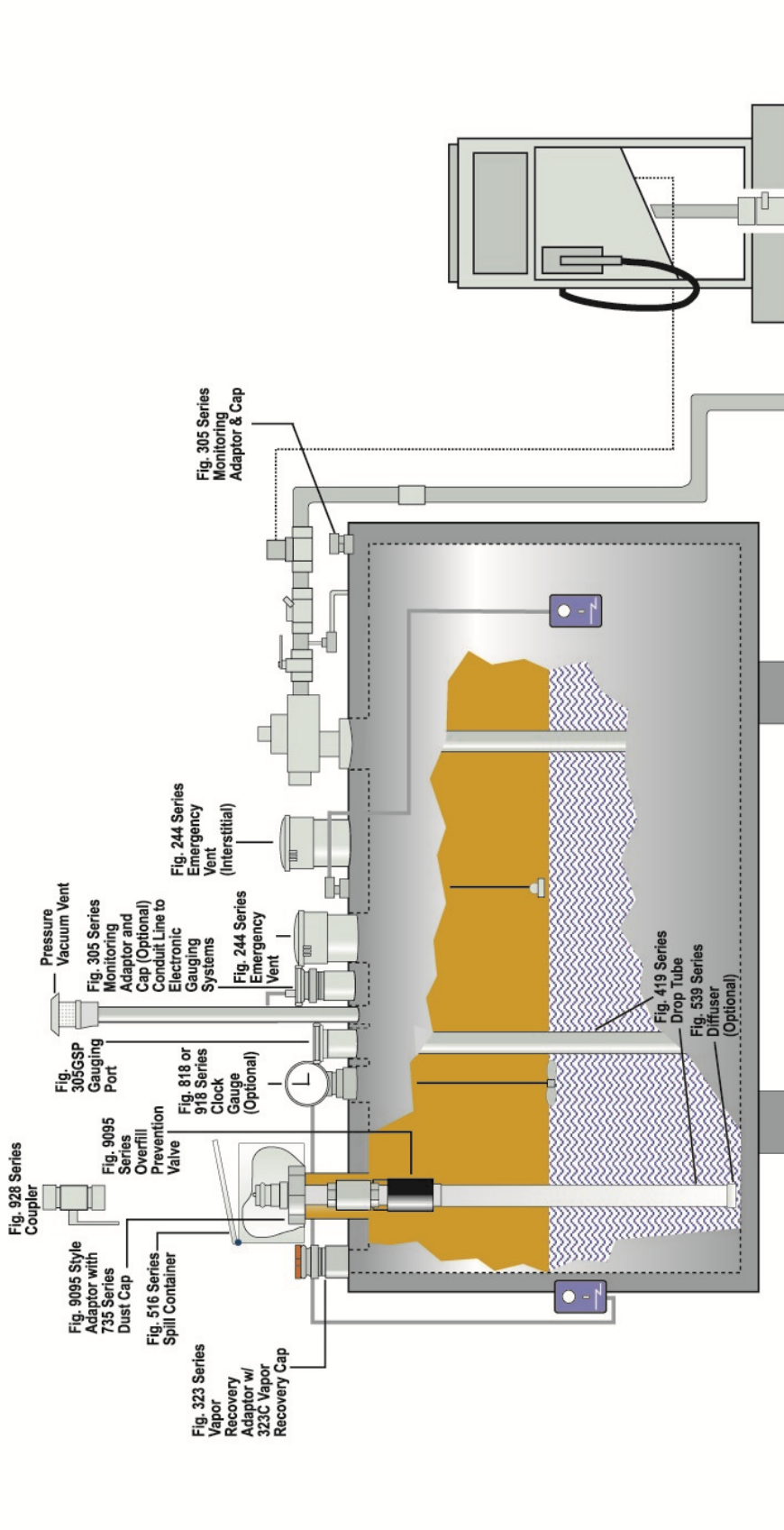

Remote Fill systems: 539 diffuser (shown, optional) or drop tube cuto at 45 degree angle. The top of diffuser opening or top of drop tube cut to be no greater than 6" from the bottom of the tank (or per local requirements outside of the State of California).

The fill pipe may have to be removed upon District request to verify that the bottom of the fill pipe is no greater than 6" from the bottom of the tank.

Figure 2L
Aboveground Fuel Storage - Suction System

Protected tank with top fill and top mounted pump

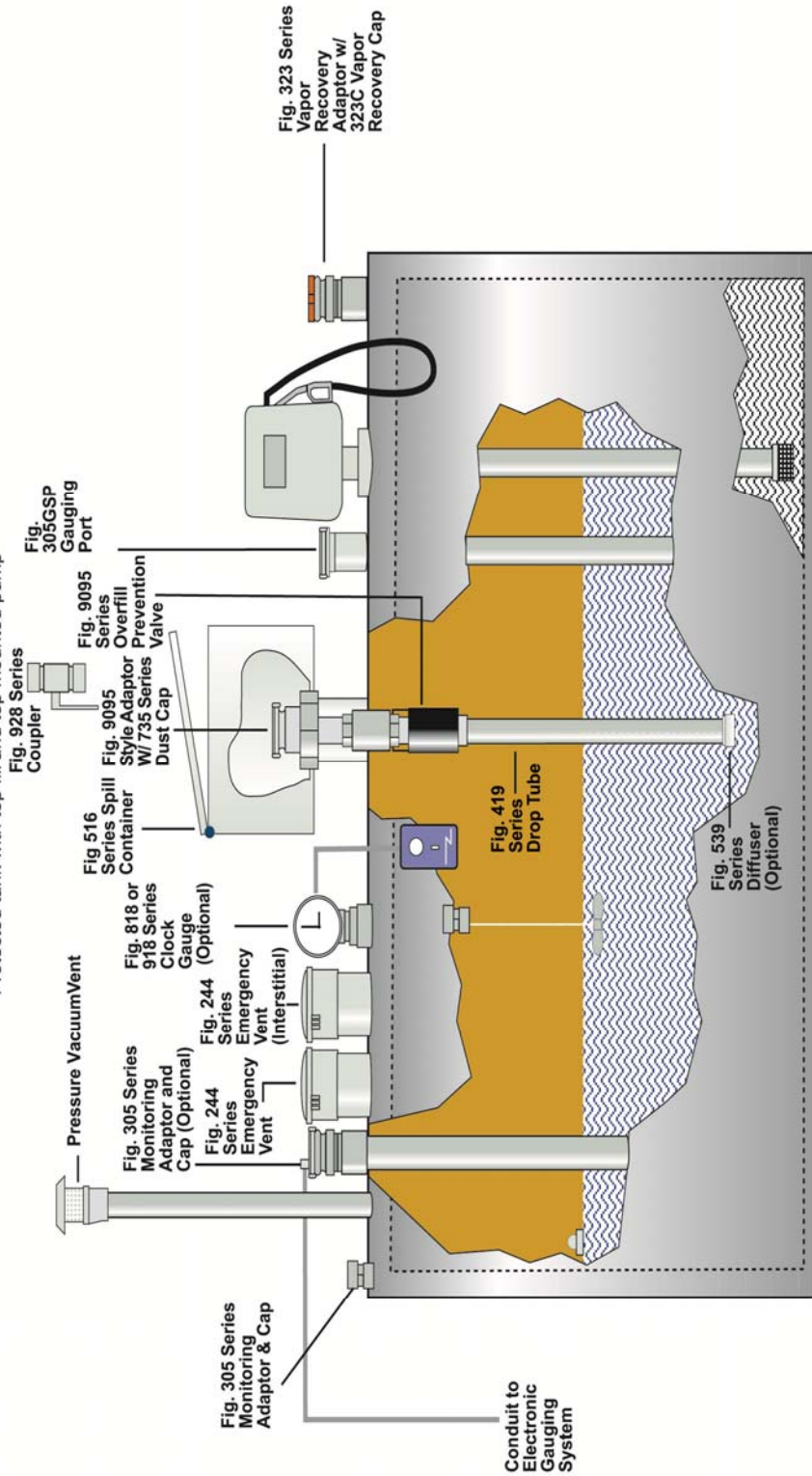

Remote Fill Systems: 539 Diffuser (shown, optional) or drop tube cut at 45 degree angle.
 The top of diffuser opening or top of drop tube cut to be no greater than 6" from the bottom of the tank (or per local requirements outside of the State of California).

The fill pipe may have to be removed upon District request to verify that the bottom of the fill pipe is no greater than 6 inches from the bottom of the tank.

Figure 2M
Aboveground Fuel Storage System With Vapor Recovery Components
 Protected Double-Wall Tank With Tank Mounted Remote Fill

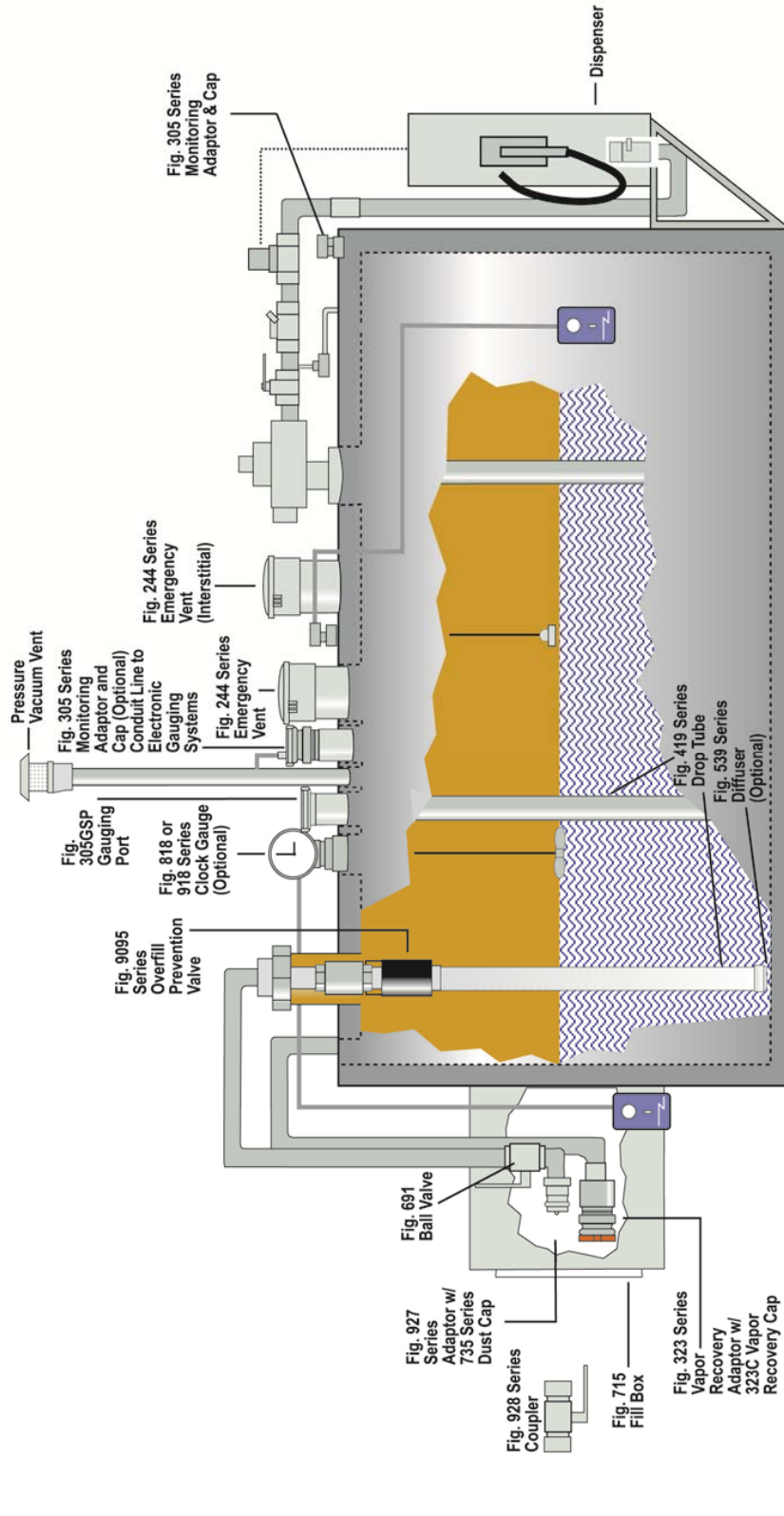

Remote Fill systems: 539 diffuser (shown, optional) or drop tube cut at 45 degree angle. The top of diffuser opening or top of drop tube cut to be no greater than 6" from the bottom of the tank (or per local requirements outside of the State of California).

The fill pipe may have to be removed upon District request to verify that the bottom of the fill pipe is no greater than 6" from the bottom of the tank.

Figure 2N: Example of a GDF Maintenance Record

Date of Maintenance/ Test/Inspection/Fail	Repair Date To Correct Test Failure	Maintenance/Test/Inspection Performed and Outcome	Affiliation	Name and Certified Technician Identification Number of Individual Conducting Maintenance or Test	Telephone Number

Exhibit 3

Manufacturing Performance Standards and Specifications and Warranty

The Morrison Bros. Phase I EVR System for aboveground storage tanks (AST) and all components shall be manufactured in compliance with the applicable Phase I performance standards and specifications in CP-206, as well as the requirements specified in this Executive Order. All components shall be manufactured as certified; no change to the equipment, parts, design, materials or manufacturing process shall be made unless approved in writing by the Executive Officer. Unless specified in Exhibit 2 or in the ***ARB Approved Installation, Operation and Maintenance Manual for the Morrison Bros. Phase I Enhanced Vapor Recovery System for Aboveground Storage Tanks***, the requirements of this section apply to the manufacturing process and are not appropriate for determining the compliance status of a gasoline dispensing facility (GDF).

Non-rotatable Product and Vapor Recovery Adaptors

1. The non-rotatable product and vapor recovery adaptors shall not leak.
2. The Morrison Bros. non-rotatable product adaptor cam and groove is not manufactured in accordance with the cam and groove specifications shown in Figure 4A of CP-206. This was deemed acceptable since the Morrison Bros. product coupler shall be used during fuel transfers to reduce the amount spillage that would otherwise occur.
3. The non-rotatable vapor recovery adaptor cam and groove shall be manufactured in accordance with the cam and groove specifications shown in Figure 4B of CP-206.
4. Each Morrison Bros. non-rotatable vapor recovery adaptor and non-rotatable product adapter shall be tested at the factory to have a zero leak rate.

Drop Tube Overfill Prevention Device

Each Drop Tube Overfill Prevention Device shall be tested at the factory to, and meet, the specification listed in table 3-1. The overfill device is installed downstream of the Morrison Bros. product adaptor (see figures 2A and 2E, Exhibit 2) which has a built in poppet to prevent spillage of product after delivery and vapors from escaping.

Emergency Vents

Each emergency vent shall be tested at the factory to, and meet, the specification listed in table 3-1. Emergency vents are not certified with an allowable leak rate and shall not leak.

Tank Gauge Components

Tank gauge components shall be tested at the factory to, and meet, the specification listed in table 3-1. Tank gauge components are not certified with an allowable leak rate and shall not leak.

Product Coupler

Each product coupler shall be tested before shipment to meet the specification listed in table 3-1. Morrison Bros. product couplers shall fit the matching non-rotatable Morrison Bros. product adapters.

**Table 3-1
Manufacturing Component Standards and Specifications**

Component	Test Method	Standard or Specification
Phase I Product Adaptors*	Exhibit 4	No Leaks
Phase I Vapor Adaptors	Micrometer	Cam and Groove Standard (CP-206)
Overfill Prevention Device	Morrison Bros. 9095 Series Test Procedure	Maximum leakage of 2% of maximum rated flow per CAN/ULC-S661
Emergency Vent	Morrison Bros. 244 Series Test Procedure	No Leaks
Tank Gauge	Morrison Bros. 818/918 Series Test Procedure	No Leaks
Product Coupler	Morrison Bros. 928 Series Test Procedure	No Leaks

* Product adaptor does not meet cam and groove standard. This was deemed acceptable because the Morrison Bros. coupler shall be used for product delivery.

Morrison Bros. Warranty

WARRANTY— All Morrison products are thoroughly tested before shipment and meet all applicable performance standards and specifications of related ARB executive orders and vapor recovery procedures of CP-206 (Certification Procedure for Vapor Recovery Systems at Gasoline Dispensing Facilities Using Aboveground Storage Tanks) or CP-201 (Certification Procedure for Vapor Recovery Systems at Dispensing Facilities). This warranty shall include the ongoing compliance with all applicable performance standards and specifications for the duration of the warranty. Only material found to be defective in manufacture will be repaired or replaced. Claims must be made within one year from the date of installation, and Morrison Bros. Co. will not allow claims for labor or consequential damage resulting from purchase, installation or misapplication of the product. This warranty will include the initial purchaser and any subsequent purchasers of the initial equipment within the warranty period. This warranty registration must remain with the equipment and be provided to the end user. If a warranty claim needs to be pursued, a copy of this information and the invoice of these products to the purchaser must be supplied to Morrison for verification.

MORRISON BROS. CO. WARRANTY REGISTRATION

All Morrison products are thoroughly tested before shipment and meet all applicable performance standards and specifications of related ARB executive orders and vapor recovery procedures of CP-206 (Certification Procedure for Vapor Recovery Systems at Gasoline Dispensing Facilities Using Aboveground Storage Tanks) or CP-201 (Certification Procedure for Vapor Recovery Systems at Dispensing Facilities). This warranty shall include the ongoing compliance with all applicable performance standards and specifications for the duration of the warranty. Only material found to be defective in manufacture will be repaired or replaced. Claims must be made within one year from the date of installation, and Morrison Bros. Co. will not allow claims for labor or consequential damage resulting from purchase, installation or misapplication of the product. This warranty will include the initial purchaser and any subsequent purchasers of the initial equipment within the warranty period.

Installation Date: _____
 Name of Installer/Contractor _____
 Installation Company: Name _____
 Address _____
 City _____ State _____ Zip _____
 Business at Installation Site: Name _____
 Address _____
 City _____ State _____ Zip _____
 Morrison Product(s) I.D Numbers with Date of Manufacture _____

Date of manufacture can be found on the product identification label applied to the finished product. This warranty registration must remain with the equipment and be provided to the end user. If a warranty claim needs to be pursued, a copy of this information and the invoice of these products to the purchaser must be supplied to Morrison for verification.

WARRANTY-100 PP Rev. D

Exhibit 4
Determination of Static Pressure Performance of
Vapor Recovery Systems at Gasoline Dispensing Facilities with
Aboveground Storage Tanks

Definitions common to all certification and test procedures are in:

D-200 Definitions for Vapor Recovery Procedures

For the purpose of this procedure, the term "ARB" refers to the California Air Resources Board, and the term "Executive Officer" refers to the ARB Executive Officer or his or her authorized representative or designate.

1. PURPOSE AND APPLICABILITY

The purpose of this test procedure is used to quantify the vapor tightness of an aboveground storage tank (AST) installed at a gasoline dispensing facility (GDF).

This test procedure is used to determine the static pressure performance standard of a vapor recovery system during the certification process and subsequently to determine compliance with that performance standard for any installation of such a system.

The applicability of this test procedure for static pressure performance is for installations of systems with AST certified by:

CP-206 Certification Procedure for Vapor Recovery Systems at
Gasoline Dispensing Facilities Using Aboveground
Storage Tanks

2. PRINCIPLE AND SUMMARY OF TEST PROCEDURE

The entire vapor recovery system is pressurized with nitrogen to two (2.0) inches water column. The system pressure is then allowed to decay for five (5) minutes. The acceptability of the final pressure is based upon the vapor system ullage.

3. BIASES AND INTERFERENCES

- 3.1 For tanks equipped with vapor recovery processor systems, the processor must be isolated or the processor outlet is capped. Leakage at the processor will indicate a system component leak.
- 3.2 Leaks in the test equipment will bias the results toward noncompliance. Prior to conducting the test, this bias is eliminated by conducting a leak check of the equipment.

- 3.3 There shall be no Phase I bulk product deliveries into the storage tank(s) within three (3) hours prior to this test. There shall be no product dispensing within thirty (30) minutes prior to this test. There shall be no Air to Liquid or Volume to Liquid Volumetric Ratio Test (TP-201.5 or equivalent) conducted within the twenty-four (24) hour period immediately prior to this test.
- 3.4 Product levels less than four (4) inches above the highest opening at the bottom of the submerged drop tube may bias the test toward noncompliance.
- 3.5 For systems which utilize a destructive processor, power to the collection unit and the processor shall be turned off during testing.
- 3.6 For vacuum-assist systems with positive displacement vacuum pumps, which locate the vacuum producing device in-line between the Phase II vapor riser and the storage tank, the following requirements shall apply:
 - 3.6.1 A valve shall be installed at the vacuum producing device. When closed, this valve shall isolate the vapor passage downstream of the vacuum producing device.
 - 3.6.2 The upstream vapor passage (nozzle to vacuum producing device) shall also be tested. Methodology for this test shall be submitted to the Executive Officer for approval prior to submission of test results or shall be conducted in accordance with the procedures set forth in the applicable ARB Executive Order.

4. EQUIPMENT SPECIFICATIONS

- 4.1 Traffic Cones. If needed for safety, use traffic cones to encircle the area while the test is being conducted.
- 4.2 Care must be exercised to prevent exposure of testing personnel to benzene, a carcinogen. Use of appropriate safety gear such as gloves and respirator is suggested.
- 4.3 Use commercial grade nitrogen in a high pressure cylinder, equipped with a two-stage pressure regulator and one pressure per square inch gauge (psig) pressure relief valve. The minimum and maximum nitrogen feed rates into the system shall be 1.0 and 5.0 cfm (cubic feet per minute) respectively.
- 4.4 The System Leak Test Assembly is shown in Figure 1. Use a modified vapor cap compatible with the Phase I vapor adaptor. The vapor cap shall be equipped with a nitrogen inlet port.

- 4.5 Use a Dwyer flowmeter, Model RMC-104, or equivalent, to determine the required pressure setting of the delivery pressure gauge on the nitrogen supply pressure regulator. This pressure shall be set such that the nitrogen flowrate is between 1.0 and 5.0 cfm.
- 4.6 Electronic pressure measuring devices or digital pressure indicators shall be used. The maximum full-scale range of the device shall be 10 inches water column. The minimum accuracy shall be 1.5 percent of full scale and the pressure measuring device shall be readable to the nearest 0.01 inches water column. A copy of the most current calibration shall be kept with the equipment. Instrument shall be calibrated every six months.
- 4.7 Stopwatch. Use a stopwatch accurate to within 0.10 seconds to time the one-minute pressure stabilization period, and the five-minute decay test period.
- 4.8 Leak Detection Solution or a Combustible Gas Indicator. Any liquid solution designed to detect vapor leaks may be used to verify the pressure integrity of system components during this test; or a combustible gas detector that complies with the requirements of U.S. EPA Method 21, "Determination of Volatile Organic Compounds Leaks", 40 CFR Ch. 1, Part 60, App. A-7 (36 FR 24877, December 23, 1971) and section 5 of this test procedure. Personnel shall assume that the combustible gas detector will be operated in an explosive atmosphere and comply with all pertinent regulations.

5. CALIBRATION PROCEDURE

- 5.1 The electronic pressure measuring device or digital pressure indicator shall be calibrated using a National Institute of Standards and Technology (NIST) traceable standard or reference standard traceable to NIST within 180 days prior to conducting the testing and the calibration. In addition, calibration shall be conducted after any repairs or alterations to the pressure measuring or indicating device. Calibrations shall be conducted per manufacturer's instructions, ensuring it complies with the minimum accuracy requirement of 1.5 percent of full scale. A copy of the most current calibration shall be kept with the equipment.
- 5.2 The flowmeter shall be calibrated every 180 days using a NIST traceable standard or a reference standard traceable to NIST as specified by the manufacturer's instructions.
- 5.3 Calibrate the combustible gas detector per the manufacturer's recommendation. Calibration gas shall be certified traceable to NIST-SRM.
 - 5.3.1 The calibration gases must be certified according to one of the following options:

5.3.1.1 The EPA Traceability Protocol for Assay and Certification of Gaseous Calibration Standards (EPA-600/R-12/531, May 2012), or

5.3.1.2 To an analytical accuracy of ± 2 percent, traceable to a reference material approved by the National Institute of Standards and Technology (NIST) and recertified annually.

5.3.2 Documentation. Information on calibration gas cylinders shall be entered into a log identifying each cylinder by serial number. Sufficient information shall be maintained to allow a determination of the certification status of each calibration gas and shall include: (1) the date put in service, (2) assay result, (3) the dates the assay was performed, (4) the organization and specific personnel who performed the assay, and (5) the date taken out of service.

6. PRE-TEST PROCEDURES

- 6.1 Place the traffic cones around the perimeter of the testing area, allowing sufficient space to safely conduct the test.
- 6.2 Electronic manometers shall have a warm-up period of at least 15 minutes followed by a five-minute drift check. If the drift exceeds 0.01 inches water column, the instrument should not be used.
- 6.3 Record system information on Form 1.
- 6.4 The minimum ullage during the test shall be 25 percent of the tank capacity and the maximum ullage during the test shall be 75 percent of the tank capacity. For manifolded tanks, the minimum ullage during the test shall be 25 percent of the aggregate tank capacity and the maximum ullage during the test shall be 75 percent of the aggregate tank capacity.
- 6.5 Determine the allowable system leak rate using Equation 8-1 in section 8.
- 6.6 Ensure the nozzle(s) are properly hung in the dispenser boot and all dispenser cabinet covers are in place. No dispensing shall be allowed during the test.
- 6.7 If a steel-braided nitrogen supply line is not used, a ground strap should be employed during the introduction of nitrogen into the system.
- 6.8 This test shall be conducted with the dust caps removed from both the product and the vapor coupler(s).

- 6.9 If the Phase I containment box is equipped with a drain valve, this test shall be conducted with the drain valve installed.
- 6.10 Conduct visual inspection of vapor recovery components to ensure no cracks, tears, or other anomalies are present that may cause a failure of the leak test.
- 6.11 Install system leak test assembly. An example is shown in Figure 1. Additional examples can be found in TP-201.3 (Figures 1-3).

7. TEST PROCEDURE

- 7.1 Observe the initial storage tank pressure. If the initial pressure is greater than one-half (0.50) inch H₂O gauge, proceed to Section 7.1.1. If the initial pressure is less than zero (0.00) inch H₂O gauge, proceed to Section 7.1.2. In the case where the storage tank pressure is between 0.00 and 0.50 inches H₂O, proceed to section 7.2.
 - 7.1.1 If the initial storage tank pressure is greater than one-half (0.50) inch H₂O gauge, carefully bleed off the excess pressure in accordance with all applicable safety procedures for a maximum of 30 seconds. Do not allow the tanks to remain open to atmosphere for more than 30 seconds or the ingestion of fresh air and additional vapor growth may result. Start the stopwatch and measure the storage tank pressure for three (3) minutes. If the 3-minute pressure exceeds 0.50 inches H₂O or continues to change at a rate exceeding ± 0.02 inches H₂O in 3 minutes, repeat this Section. Several attempts may be required.
 - 7.1.2 If the initial storage tank pressure is less than zero (0.00) inches H₂O gauge, slowly introduce nitrogen so that the storage tank pressure is between zero (0.00) and one-half (0.50) inches H₂O gauge. Start the stopwatch and measure the storage tank pressure for three (3) minutes. If the 3-minute pressure is not between 0.00 and 0.50 inches H₂O or continues to change at a rate exceeding ± 0.02 inches H₂O in 3 minutes, repeat this Section.
- 7.2 Open the nitrogen gas supply valve, regulate the delivery pressure to at least 10 psig, and pressurize the vapor system (or subsystem for individual vapor return line systems) to or slightly above 2 inches water column. The minimum and maximum nitrogen feed rates in to the system shall be 1.0 and 5.0 cfm respectively. It is critical to maintain the flow until both flow and pressure stabilize, indicating temperature and pressure stabilization in the tanks. Close the nitrogen supply valve.
- 7.3 Check the system leak test assembly using leak detection solution to verify that the test equipment is leak tight. Quickly remove the vapor cap assembly.
- 7.4 Re-open the nitrogen supply valve, and reset the tank pressure to reestablish a pressure slightly greater than 2 inches water column. Close the nitrogen supply

valve and start the stopwatch when the pressure reaches an initial pressure of 2.0 inches of water column.

- 7.5 At one-minute intervals during the test, record the system pressure on Form 1. After five minutes, record the final system pressure on Form 1. Carefully remove the system leak test assembly.
- 7.6 Use Equation 8-1 in section 8 or Table 1 to determine the compliance status of the facility by comparing the final five-minute pressure with the minimum allowable pressure.

Figure 1
Typical System Leak Test Assembly

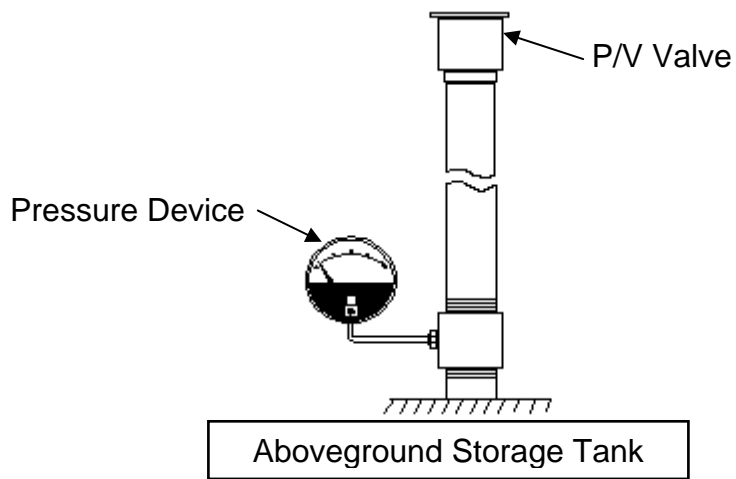
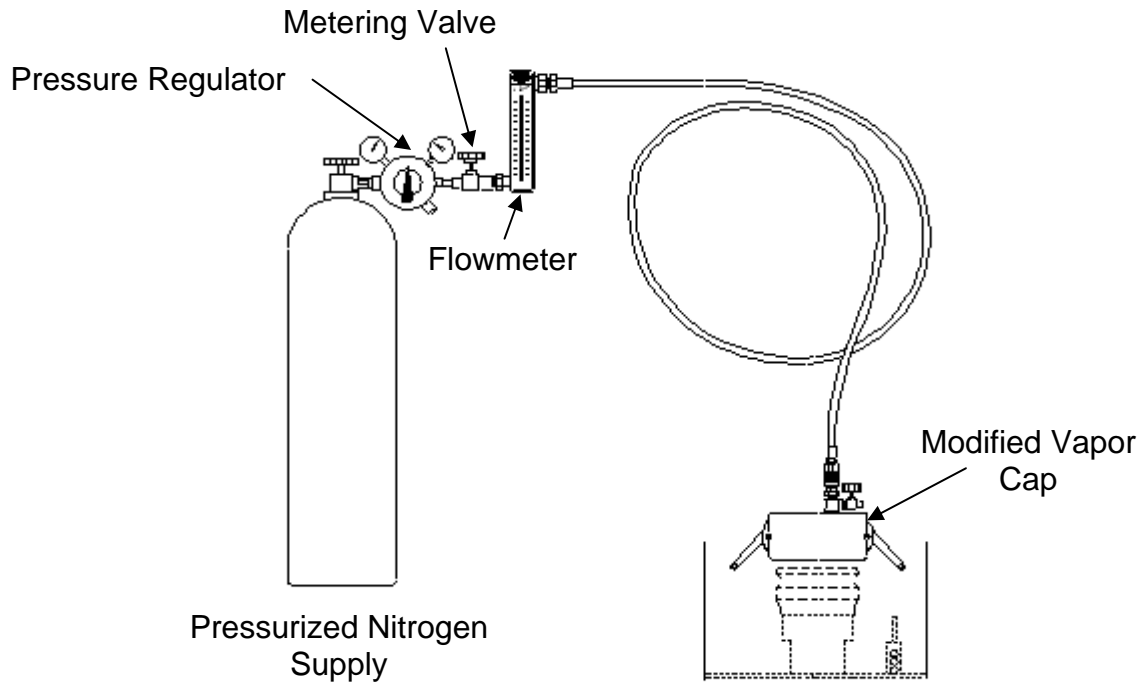

8. CALCULATING RESULTS

Minimum Allowable Pressure

The minimum allowable pressure after five (5) minutes, with an initial pressure of 2.0 inches water column, shall be calculated as shown below, or obtained from Table 1:

Equation 8-1

$$P_f = 2e^{(-223.9/V)}$$

where:

P_f	=	Minimum pressure after 5 minutes, inches water column
V	=	Ullage of the system, gallons
e	=	Constant equal to 2.71828
2	=	Initial starting pressure, inches water column
-223.9	=	Decay constant for a 5 minute test

9. REPORTING RESULTS

Report the results as indicated on Form 1. District may require the use of alternate forms provided they include the same minimum parameters identified in Form 1.

10. ALTERNATIVE TEST PROCEDURES

This procedure shall be conducted as specified. Modifications to this test procedure shall not be used to determine compliance unless prior written approval has been obtained from the ARB Executive Officer, pursuant to Section 15 of Certification Procedure CP-206.

**Form 1
Summary of Source Test Data**

Static Pressure Performance Test					
<p>GDF Name and Address:</p> <p>GDF Representative and Title:</p> <p>GDF Phone #:</p> <p>GDF # _____</p> <p>Manifolded? Y or N</p>	<p align="center">PHASE II SYSTEM TYPE (Check One)</p> <p>Balance _____</p> <p>VacAssist _____</p> <p>Other _____</p> <p>Manufacturer: _____</p> <p>Permit Conditions:</p>				
	TANK # :	1	2	3	4
<p>1. Product Grade</p> <p>2. Actual Tank Capacity, gallons</p> <p>3. Gasoline Volume</p> <p>4. Ullage, gallons (ullage = capacity-volume)</p> <p>5. Initial Pressure (inches water column)</p> <p>6. Pressure After 1 Minute</p> <p>7. Pressure After 2 Minutes</p> <p>8. Pressure After 3 Minutes</p> <p>9. Pressure After 4 Minutes</p> <p>10. Final Pressure After 5 Minutes</p> <p>11. Allowable Final Pressure</p>					
<p>Test Conducted by:</p> <p>Date of Test:</p>	<p>Test Company:</p> <p>Test Contractor Certification Number:</p> <p>Expiration Date:</p>				

TABLE 1
Leak Rate Criteria

ULLAGE (GALLONS)	MINIMUM PRESSURE AFTER 5 MINUTES, (INCHES OF WATER COLUMN)
100	0.21
150	0.45
200	0.65
250	0.82
300	0.95
350	1.05
400	1.14
450	1.22
500	1.28
550	1.33
600	1.38
650	1.42
700	1.45
750	1.48
800	1.51
850	1.54
900	1.56
950	1.58
1,000	1.60
1,200	1.66
1,400	1.70
1,600	1.74
1,800	1.77
2,000	1.79
2,200	1.81
2,400	1.82
2,600	1.83
2,800	1.85
3,000	1.86
3,500	1.88
4,000	1.89
4,500	1.90
5,000	1.91
6,000	1.93
7,000	1.94
8,000	1.94
9,000	1.95
10,000	1.96
15,000	1.97
20,000	1.98

Exhibit 5
Alternate Phase I EVR Installation Configurations for
Existing Aboveground Storage Tanks

Existing aboveground storage tanks (AST) may be configured with a limited number of available bung openings and bung diameters. In order to provide flexibility in regards to Phase I EVR equipment installation, the figures in this exhibit provide examples of typical alternate Phase I EVR installation configurations.

General Specifications

1. Alternate installation configurations for the Morrison Bros. Phase I EVR System (Morrison System) for existing ASTs are shown in Figures 5A, 5B, and 5C.
2. A properly sized, dedicated opening must be provided for the emergency vent in accordance with Section 1 of the ***ARB Approved Installation, Operation and Maintenance Manual for the Morrison Bros. Phase I Enhanced Vapor Recovery System for Aboveground Storage Tanks.***
3. The Morrison System shall be installed, operated, and maintained in accordance with ***ARB Approved Installation, Operation and Maintenance Manual for the Morrison Bros. Phase I Enhanced Vapor Recovery System for Aboveground Storage Tanks.***
4. Any repair or replacement of system components shall be done in accordance with ***ARB Approved Installation, Operation and Maintenance Manual for the Morrison Bros. Phase I Enhanced Vapor Recovery System for Aboveground Storage Tanks.***
5. Unless otherwise specified in this Executive Order (EO), the Morrison System shall comply with the applicable performance standards and performance specifications in CP-206.
6. Maintenance and repair of system components, including removal and installation of such components in the course of any required tests, shall be performed by Morrison Bros. Certified Technicians.
7. Per Exhibit 2 of the Executive Order, the diameter of return vapor piping of AST shall be greater than or equal to diameter of the associated drop tube.
8. Other alternate installation configurations may be utilized if approved by the local air pollution control district and fire marshal/fire agency.

Figure 5A
Alternate Phase I Installation Configurations for Existing Aboveground Storage Tanks

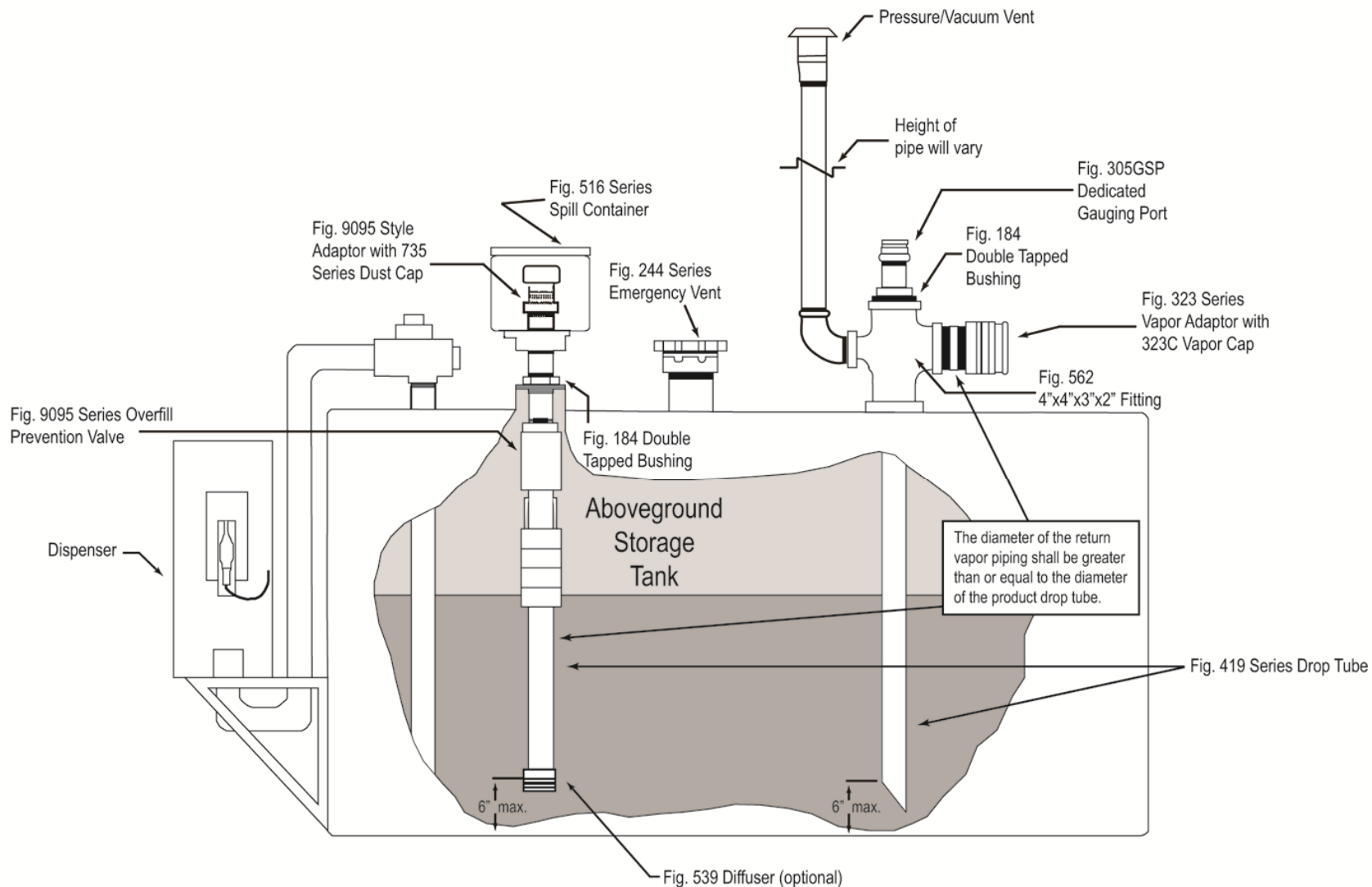

Tank gauging may be done by way of a dedicated port, mechanical gauge, or electronic gauge.

Figure 5B
Alternative Phase I Installation Configurations for Existing Aboveground Storage Tanks

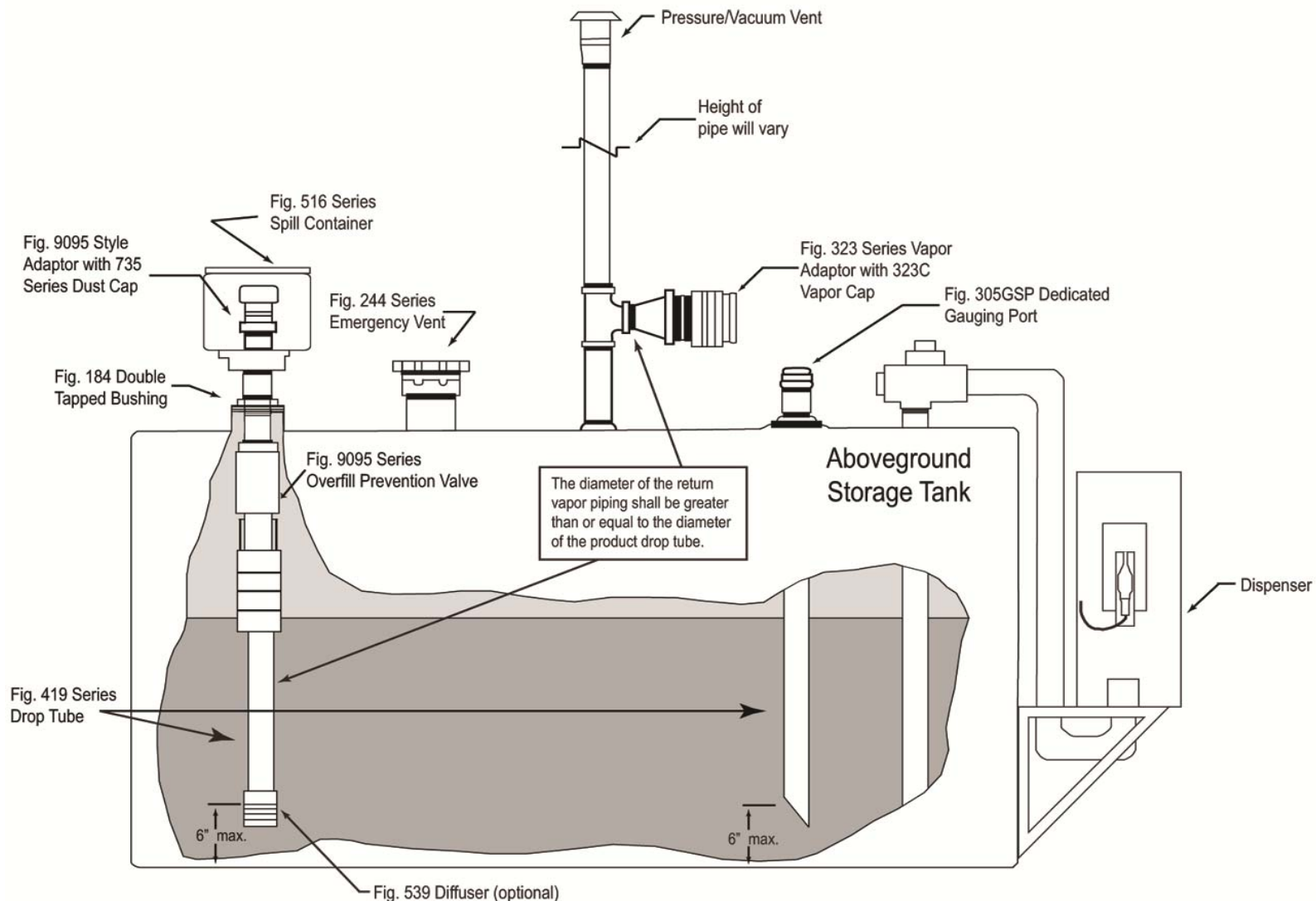

Tank gauging may be done by way of a dedicated port, mechanical gauge, or electronic gauge.

Morrison Bros. Phase I EVR System for Aboveground Storage Tanks – VR-402-B

Figure 5C
Alternate Phase I Installation Configurations for Existing Aboveground Storage Tanks

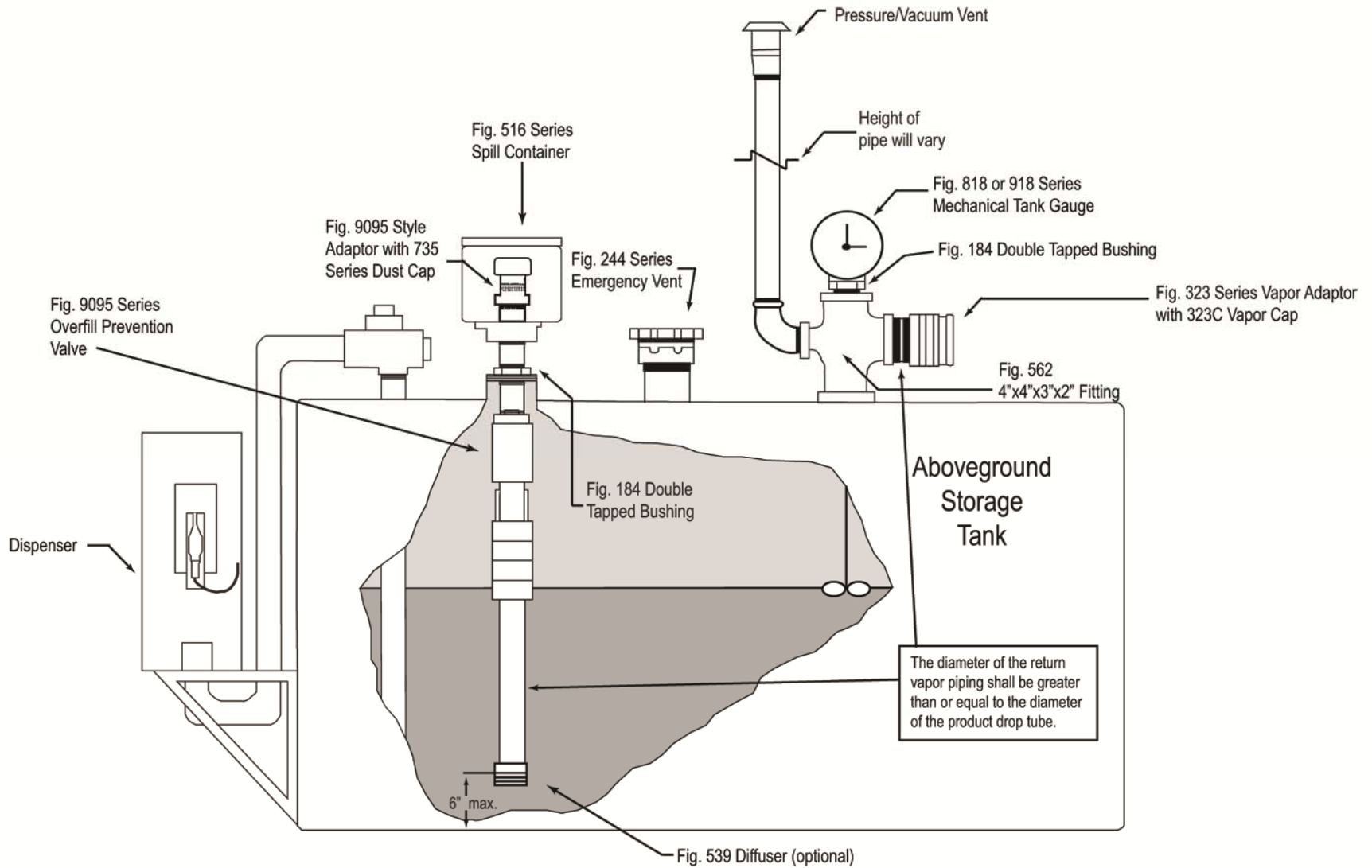

Tank gauging may be done by way of a mechanical or electronic gauge.